

KUDOS

SHOWERING SOLUTIONS



CORE COLLECTION



RONAL Bathrooms UK

KUDOS

SHOWERING SOLUTIONS





CORE COLLECTION

Create the perfect solution for your bathroom

The Kudos Core collection is a carefully curated collection of products designed to have universal appeal whilst also ensuring that there is a solution for every budget and every space, from a small en-suite to a large family bathroom and everything in between.

Established in 1999 Kudos Showers design and manufacture high quality showering products, bringing together innovative design, functionality and value. Helping you to create the perfect solution for your bathroom.

Now part of the wider RONAL Bathrooms Group, Kudos continues to manufacture high quality products in their factory in the stunning Lake District.



*See website for details.

KUDOS

SHOWERING SOLUTIONS





CORE COLLECTION

Contents

shower Enclosures	7-39
walk-in Enclosures	41-63
bathscreens Overbath	65-81
shower Trays	83-87
wetroom Systems	89-97
bespoke Solutions	97-98



*See website for details.





CORE COLLECTION

shower

Enclosures

The Kudos Core Collection of shower enclosures includes the Divera and Siona ranges, with each range representing great value and fantastic quality. Featuring pivot, sliding, bi-fold and quadrant doors ensuring that there is something suitable for every size and style of bathroom.

Whether you're looking for a traditional 'framed' or a more contemporary semi-frameless enclosure, simple (yet stunning) chrome or a stylish matt black finish then these ranges are perfect for you.

Every Kudos product is treated with LifeShield protective coating for easy cleaning and is backed by the Kudos Lifetime Guarantee.



*See website for details.

Chrome straight sliding corner enclosure



Chrome quadrant enclosure



divera

Enclosures & Walk-ins

Elegant and sophisticated, this modular range of enclosures includes sliding, corner entry, bi-fold, hinged and quadrant options, which, when used in conjunction with Divera side panels and accessories, can be used to create a wide variety of configurations.

Designed with your comfort in mind, this 6mm range of enclosures is available in either chrome or matt black finishes, is treated with a protective coating for easy cleaning and features slim, ergonomic, handles. All backed by the Kudos Lifetime Guarantee.

Features & Benefits

- + 2000mm high
- + 6mm toughened safety glass
- + Protective coating for easy cleaning
- + Modular shower enclosures
- + Available in chrome or matt black finishes
- + Lifetime guarantee

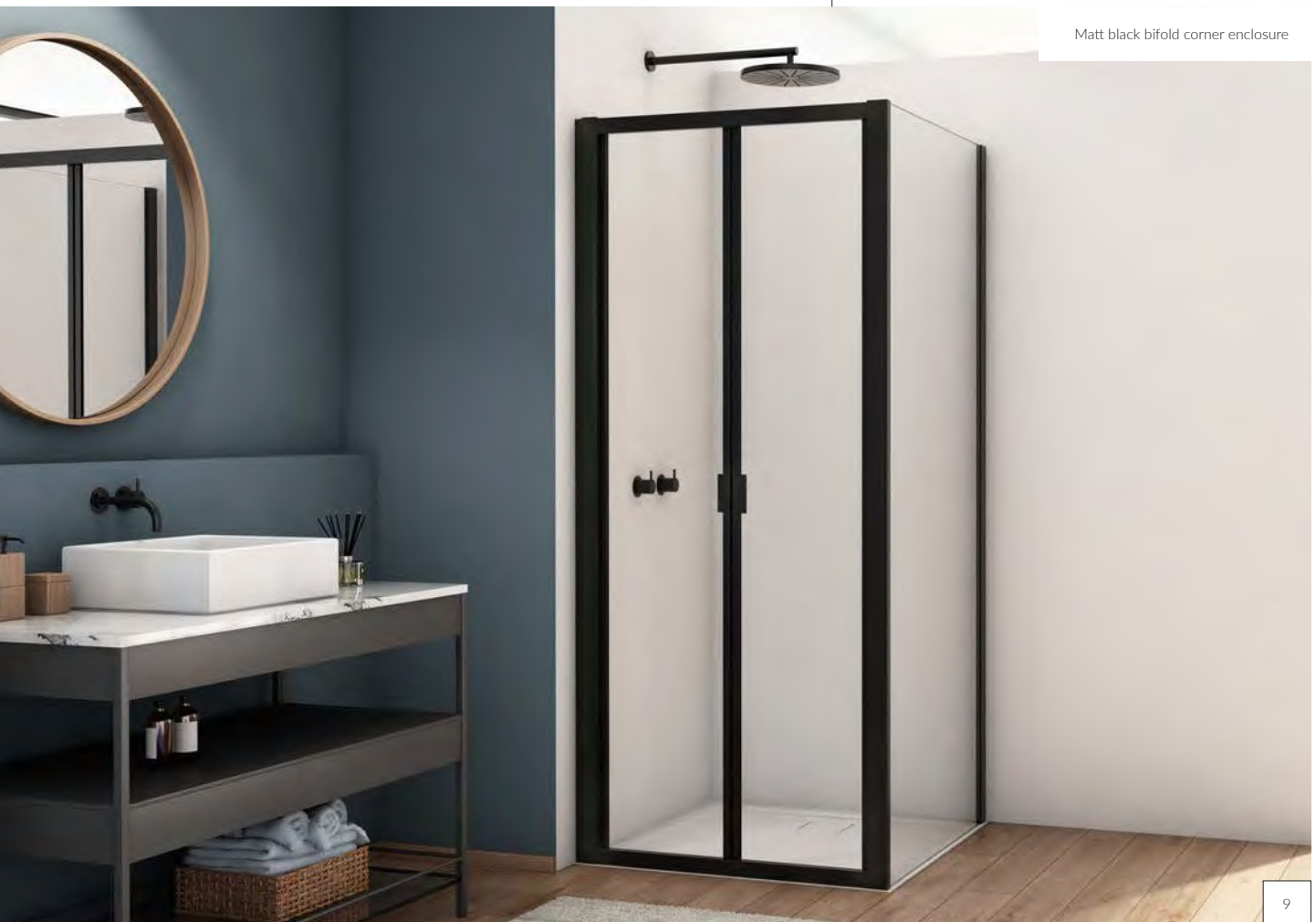

Matt black bifold corner enclosure

divera

Pivot corner doors

Suitable for all bathroom spaces, the stylish Divera pivot door is available in 5 door sizes and can be used for either corner or recess installations.

Features & Benefits

- + 2000mm high
- + 6mm toughened safety glass
- + Protective coating for easy cleaning
- + In/out pivot action
- + Suitable for corner or recess
- + Modular shower enclosure
- + Available in chrome or matt black finishes
- + Lifetime guarantee

Door Packs

Product Description	Chrome Product Code	Matt Black Product Code	Height (mm)	Door Width (mm)	Access (mm)
Pivot Door 700mm	K22T10705007-0001	K22T10700607-0001	2000	700	530
Pivot Door 760mm	K22T10765007-0001	K22T10760607-0001	2000	760	590
Pivot Door 800mm	K22T10805007-0001	K22T10800607-0001	2000	800	630
Pivot Door 900mm	K22T10905007-0001	K22T10900607-0001	2000	900	730
Pivot Door 1000mm	K22T11005007-0001	K22T11000607-0001	2000	1000	830

Please see **page 26** for side panel options

Installation Dimensions & Adjustments

Width	Installation on a shower tray
	Corner (door + side panel) (-20mm; +10mm)
700mm	680-710
760mm	740-770
800mm	780-810
900mm	880-910
1000mm	980-1010

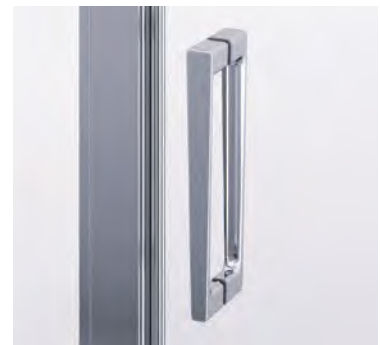

Ergonomic handle

Optional Components

Product Description	Chrome Product Code	Matt Black Product Code
Extension Post 25mm	AK221.50.2000-0001	AK221.06.2000-0001
Inline to Side Panel Bracket	K22FPG.10	K22FPG.06
*Slimline Threshold Strip (1000mm)	K22KB.10	K22KB.06

*Use with 1000mm door only



Chrome pivot corner enclosure



Matt black pivot corner enclosure

divera

Pivot recess doors

Suitable for all bathroom spaces, the stylish Divera pivot door is available in 5 door sizes and can be used for either corner or recess installations.

Features & Benefits

- + 2000mm high
- + 6mm toughened safety glass
- + Protective coating for easy cleaning
- + In/out pivot action
- + Suitable for corner or recess
- + Modular shower enclosure
- + Available in chrome or matt black finishes
- + Lifetime guarantee

Door Packs

Product Description	Chrome Product Code	Matt Black Product Code	Height (mm)	Door Width (mm)	Access (mm)
Pivot Door 700mm	K22T10705007-0001	K22T10700607-0001	2000	700	530
Pivot Door 760mm	K22T10765007-0001	K22T10760607-0001	2000	760	590
Pivot Door 800mm	K22T10805007-0001	K22T10800607-0001	2000	800	630
Pivot Door 900mm	K22T10905007-0001	K22T10900607-0001	2000	900	730
Pivot Door 1000mm	K22T11005007-0001	K22T11000607-0001	2000	1000	830

Installation Dimensions & Adjustments

Width	Installation on a shower tray
	Recess (-40mm, +20mm)
700mm	660-720
760mm	720-780
800mm	760-820
900mm	860-920
1000mm	960-1020

Optional Components

Product Description	Chrome Product Code	Matt Black Product Code
Extension Post 25mm	AK221.50.2000-0001	AK221.06.2000-0001
Inline to Side Panel Bracket	K22FPG.10	K22FPG.06
*Slimline Threshold Strip (1000mm)	K22KB.10	K22KB.06

*Use with 1000mm door only



Discreet threshold profile



Chrome pivot recess enclosure



Matt black pivot recess enclosure

divera

Bifold corner doors

This elegant space saving shower enclosure features an inward folding door which is perfect for instances where external space is limited.

Features & Benefits

- + 2000mm high
- + 6mm toughened safety glass
- + Protective coating for easy cleaning
- + Suitable for corner, recess or 3 sided*
- + Modular shower enclosure
- + Available in chrome or matt black finishes
- + Lifetime guarantee

Door Packs

Product Description	Chrome Product Code	Matt Black Product Code	Height (mm)	Door Width (mm)	Access (mm)
Bifold Door 760mm	K22K0765007-0001	K22K0760607-0001	2000	760	510
Bifold Door 800mm	K22K0805007-0001	K22K0800607-0001	2000	800	550
Bifold Door 900mm	K22K0905007-0001	K22K0900607-0001	2000	900	650
Bifold Door 1000mm	K22K1005007-0001	K22K1000607-0001	2000	1000	750

Please see **page 26** for side panel options

Installation Dimensions & Adjustments

Width	Installation on a shower tray	
	Corner (door + side panel) (-20mm; +10mm)	3 sided (door + 2 x Side panel) (-20mm; +5mm)
760mm	740-770	740-765
800mm	780-810	780-805
900mm	880-910	880-905
1000mm	980-110	980-1005



Bifold pull handle

Optional Components

Product Description	Chrome Product Code	Matt Black Product Code
Bifold Extension Post 25mm	AK222.50.2000-0001	AK222.06.2000-0001
Inline to Side Panel Bracket	K22FPG.10	K22FPG.06



Scan the QR code for more information on 3 sided configurations



Chrome bifold corner enclosure



Matt black bifold corner enclosure

divera

Bifold recess doors

This elegant space saving shower enclosure features an inward folding door which is perfect for instances where external space is limited.

Features & Benefits

- + 2000mm high
- + 6mm toughened safety glass
- + Protective coating for easy cleaning
- + Suitable for corner, recess or 3 sided*
- + Modular shower enclosure
- + Available in chrome or matt black finishes
- + Lifetime guarantee

Door Packs

Product Description	Chrome Product Code	Matt Black Product Code	Height (mm)	Door Width (mm)	Access (mm)
Bifold Door 760mm	K22K0765007-0001	K22K0760607-0001	2000	760	510
Bifold Door 800mm	K22K0805007-0001	K22K0800607-0001	2000	800	550
Bifold Door 900mm	K22K0905007-0001	K22K0900607-0001	2000	900	650
Bifold Door 1000mm	K22K1005007-0001	K22K1000607-0001	2000	1000	750

Installation Dimensions & Adjustments

Width	Installation on a shower tray
	Recess (-40mm, +20mm)
760mm	720-780
800mm	760-820
900mm	860-920
1000mm	960-1020

Optional Components

Product Description	Chrome Product Code	Matt Black Product Code
Bifold Extension Post 25mm	AK222.50.2000-0001	AK222.06.2000-0001
Inline to Side Panel Bracket	K22FPG.10	K22FPG.06



Discreet threshold profile



Scan the QR code for more information on 3 sided configurations



Chrome bifold corner enclosure



Matt black bifold recess enclosure

divera

Straight sliding corner doors

Available in 5 door sizes and two colour finishes, the Divera straight sliding door features a stylish ergonomic handle and is easy to clean.

Features & Benefits

- + 2000mm high
- + 6mm toughened safety glass
- + Protective coating for easy cleaning
- + Quick release sliding door
- + Suitable for corner, recess or 3 sided*
- + Available in chrome or matt black finishes
- + Lifetime guarantee

Door Packs

Product Description	Chrome Product Code	Matt Black Product Code	Height (mm)	Door Width (mm)	Fixed Panel Width (mm)	Access (mm)
Straight Sliding Door 1000mm	K22S2B1005007-0001	K22S2B1000607-0001	2000	1000	469	384
Straight Sliding Door 1100mm	K22S2B1105007-0001	K22S2B1100607-0001	2000	1100	519	434
Straight Sliding Door 1200mm	K22S2B1205007-0001	K22S2B1200607-0001	2000	1200	569	484
Straight Sliding Door 1300mm	K22S2B1305007-0001	K22S2B1300607-0001	2000	1300	619	534
Straight Sliding Door 1400mm	K22S2B1405007-0001	K22S2B1400607-0001	2000	1400	669	584

Please see **page 26** for side panel options

Installation Dimensions & Adjustments

Width	Installation on a shower tray	
	Corner (door + side panel) (-20mm; +10mm)	3 sided (door + 2 x Side panel) (-20mm; +5mm)
1000mm	980-1010	980-1005
1100mm	1080-1110	1080-1105
1200mm	1180-1210	1180-1205
1300mm	1280-1310	1280-1305
1400mm	1380-1410	1380-1405



Unhookable system for easy cleaning

Optional Components

Product Description	Chrome Product Code	Matt Black Product Code
Extension Post 25mm	AK221.50.2000-0001	AK221.06.2000-0001
Inline To Side Panel Bracket	K22FPG.10	K22FPG.06



Scan the QR code for more information on 3 sided configurations



Chrome straight sliding corner enclosure



Matt black straight sliding corner enclosure

divera

Straight sliding recess doors

Available in 5 door sizes and two colour finishes, the Divera straight sliding door features a stylish ergonomic handle and is easy to clean.

Features & Benefits

- + 2000mm high
- + 6mm toughened safety glass
- + Protective coating for easy cleaning
- + Quick release sliding door
- + Suitable for corner, recess or 3 sided*
- + Available in chrome or matt black finishes
- + Lifetime guarantee

Door Packs

Product Description	Chrome Product Code	Matt Black Product Code	Height (mm)	Door Width (mm)	Fixed Panel Width (mm)	Access (mm)
Straight Sliding Door 1000mm	K22S2B1005007-0001	K22S2B1000607-0001	2000	1000	469	384
Straight Sliding Door 1100mm	K22S2B1105007-0001	K22S2B1100607-0001	2000	1100	519	434
Straight Sliding Door 1200mm	K22S2B1205007-0001	K22S2B1200607-0001	2000	1200	569	484
Straight Sliding Door 1300mm	K22S2B1305007-0001	K22S2B1300607-0001	2000	1300	619	534
Straight Sliding Door 1400mm	K22S2B1405007-0001	K22S2B1400607-0001	2000	1400	669	584

Installation Dimensions & Adjustments

Width	Installation on a shower tray
	Recess (-40mm, +20mm)
1000mm	960-1020
1100mm	1060-1120
1200mm	1160-1220
1300mm	1260-1320
1400mm	1360-1420



Unhookable system for easy cleaning

Optional Components

Product Description	Chrome Product Code	Matt Black Product Code
Extension Post 25mm	AK221.50.2000-0001	AK221.06.2000-0001
Inline To Side Panel Bracket	K22FPG.10	K22FPG.06



Scan the QR code for more information on 3 sided configurations



Chrome straight sliding recess enclosure



Matt black straight sliding recess enclosure

divera

Sliding corner entry doors

Transform a corner in your bathroom with the Divera sliding corner entry enclosure. Available in two colour finishes, this enclosure features removable sliding doors for easy cleaning

Features & Benefits

- + 2000mm high
- + 6mm toughened safety glass
- + Protective coating for easy cleaning
- + Available in chrome or matt black finishes
- + Add an inline panel for rectangular corner entry
- + Lifetime guarantee

Door Packs (including fixed panel)

Product Description	Chrome Product Code	Matt Black Product Code	Height (mm)	Door Width (mm)	Fixed Panel Width (mm)	Access (mm)
Sliding Corner Entry Door 700 x 700mm	K22SE2B0705007-0001	K22SE2B0700607-0001	2000	700	322	348
Sliding Corner Entry Door 800 x 800mm	K22SE2B0805007-0001	K22SE2B0800607-0001	2000	800	372	418
Sliding Corner Entry Door 900 x 900mm	K22SE2B0905007-0001	K22SE2B0900607-0001	2000	900	422	489
Sliding Corner Entry Door 1000 x 1000mm	K22SE2B1005007-0001	K22SE2B1000607-0001	2000	1000	472	560

Installation Dimensions & Adjustments

Width	Installation on a shower tray
	Corner (-20mm; +10mm)
700mm	680-710
800mm	780-810
900mm	880-910
1000mm	980-1010



Stylish handle

Optional Components

Product Description	Chrome Product Code	Matt Black Product Code
Extension Post 25mm	AK221.50.2000-0001	AK221.06.2000-0001

Please see [page 26](#) for inline panel options



Chrome sliding corner entry enclosure



Matt black sliding corner entry enclosure

divera

Quadrant and offset sliding doors

The stylish Divera quadrant shower enclosure features double sliding doors for easy access

Features & Benefits

- + 2000mm high
- + 6mm toughened safety glass
- + Protective coating for easy cleaning
- + Quick release sliding door
- + Modular shower enclosure
- + Available in chrome or matt black finishes
- + Lifetime guarantee

Door Packs (including fixed panel)

Product Description	Chrome Product Code	Matt Black Product Code	Height (mm)	Door Width (mm)	Fixed Panel Width (mm)	Access (mm)	Radius (mm)
Quadrant Sliding Double Door 800mm	K22SRB550805007-0001	K22SRB550800607-0001	2000	800	248	416	550
Quadrant Sliding Double Door 900mm	K22SRB550905007-0001	K22SRB550900607-0001	2000	900	348	551	550
Quadrant Sliding Double Door 1000mm	K22SRB551005007-0001	K22SRB551000607-0001	2000	1000	448	551	550

*Off-set enclosures can be created with the addition of the inline panel

Create An Offset Quadrant Door With Fixed Inline Panel Configurations:

Enclosure Size	Height (mm)	Door Width (mm)	Fixed Panel Width (mm)	Access (mm)
1000 x 800mm	2000	800	200	630
1200 x 800mm	2000	800	400	530
1200 x 900mm	2000	900	300	630

Installation Dimensions & Adjustments

Width	Installation on a shower tray
	Adjustment (-20mm; +10mm)
800mm	780-810
900mm	880-910
1000mm	980-1010

Optional Components

Product Description	Chrome Product Code	Matt Black Product Code
Extension post 25mm	AK221.50.2000-0001	AK221.60.2000-0001

Please see **page 26** for inline panel options



Stylish handle



Chrome quadrant enclosure



Matt black quadrant enclosure

divera

Side panels and inline panels

Compatible with all door types in the Divera range, the accessories and side panels can be used throughout the range to create a wide variety of configurations.

Features & Benefits

- + 2000mm high
- + 6mm toughened safety glass throughout
- + Protective coating for easy cleaning
- + Crystal clear seals
- + 20mm adjustment on each wall post
- + Available in chrome or matt black finishes
- + Lifetime guarantee

Side panels

Product Description	Chrome Product Code	Matt Black Product Code
700mm Side Panel	K22F10705007-0001	K22F10700607-0001
760mm Side Panel	K22F10765007-0001	K22F10760607-0001
800mm Side Panel	K22F10805007-0001	K22F10800607-0001
900mm Side Panel	K22F10905007-0001	K22F10900607-0001
1000mm Side Panel	K22F11005007-0001	K22F11000607-0001
1200mm Side Panel	K22F11205007-0001	K22F11200607-0001
1400mm Side Panel	K22F11405007-0001	K22F11400607-0001



Stabiliser bar

*Inline panels

Product Description	Chrome Product Code	Matt Black Product Code
200mm Inline Panel	K22FF0205007-0001	K22FF0200607-0001
300mm Inline Panel	K22FF0305007-0001	K22FF0300607-0001
400mm Inline Panel	K22FF0405007-0001	K22FF0400607-0001
500mm Inline Panel	K22FF0505007-0001	K22FF0500607-0001
600mm Inline Panel	K22FF0605007-0001	K22FF0600607-0001

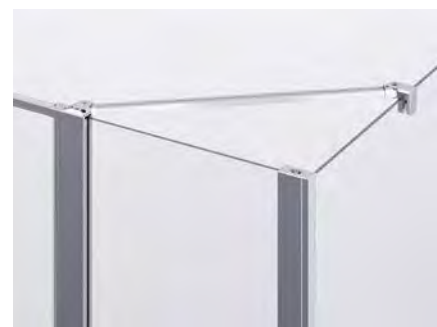

Stabiliser bar

*Includes stabiliser bar



Divera side panel



Divera inline panel

divera

Doors with inline panels

Pivot Door With Fixed Inline Panel Configurations:

Width	Height (mm)	Door Width (mm)	Fixed Panel Width (mm)	Access (mm)
900mm	2000	700	200	530
1000mm	2000	700	300	530
	2000	800	200	630
1100mm	2000	700	400	530
	2000	800	300	630
1200mm	2000	700	500	530
	2000	800	400	630
	2000	900	300	730
	2000	1000	200	830
1300mm	2000	700	600	530
	2000	800	500	630
	2000	900	400	730
1400mm	2000	1000	300	830
	2000	800	600	630
	2000	900	500	730
1500mm	2000	1000	400	830
	2000	900	600	730
1600mm	2000	1000	500	830
	2000	1000	600	830



In/out pivot mechanism



Side panel configuration

See page 26 for all side panels, inline panels and accessories that can be used with all Divera door types

Installation Dimensions & Adjustments (door with fixed inline panel)

Width	Installation on a shower tray	
	Recess (-40mm, +20mm)	Corner (door + side panel) (-20mm; +10mm)
900mm	860-920	880-910
1000mm	960-1020	980-1010
1100mm	1060-1120	1080-1110
1200mm	1160-1220	1180-1210
1300mm	1260-1320	1280-1310
1400mm	1360-1420	1380-1410
1500mm	1460-1520	1480-1510
1600mm	1560-1620	1580-1610



Wall post

Note: By adding a fixed inline panel or panels you can create the perfect enclosure for the space that you have available



Matt black pivot corner enclosure with inline panels



Chrome pivot corner enclosure with side panel

Chrome recess pivot door enclosure



Chrome corner sliding door enclosure



siona

Enclosures

The new siona 8mm range, is semi-frameless and includes pivot and straight sliding door options.

This stunning range is available in chrome and matt black finishes and combines understated minimalism with a traditional aesthetic, giving you the flexibility to create a bathroom space that will stand the test of time.

All of the products in the Siona range are 2000mm high, feature 8mm toughened safety glass throughout and are covered by the Kudos Lifetime Guarantee giving you complete peace of mind.

Features & Benefits

- + 2000mm high
- + 8mm toughened safety glass
- + Ultra clear seals
- + LifeShield protection for easy cleaning
- + Available in chrome and matt black
- + Lifetime Guarantee
- + Made In Britain

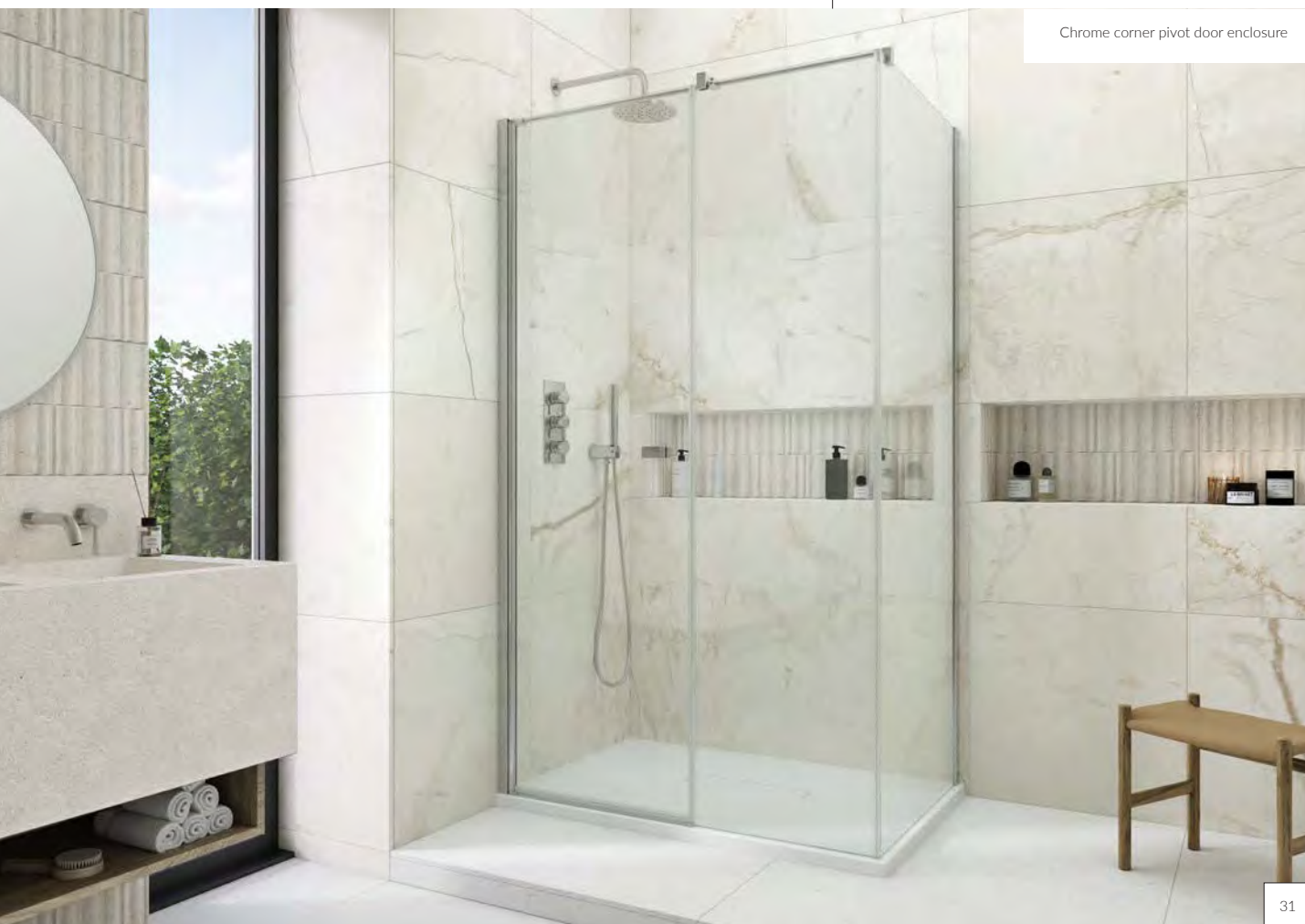

Chrome corner pivot door enclosure

siona

Pivot corner doors

The semi-frameless siona pivot door features a barrel pivot mechanism and crystal clear seals throughout and includes corner and recess door options.

Combining the benefits of a fully framed enclosure with the aesthetic of frameless enclosures, the siona pivot door is perfect for medium to large bathrooms.

Features & Benefits

- + 2000mm high
- + 8mm toughened safety glass
- + Crystal clear seals
- + Barrel pivot hinge mechanism
- + Concealed fittings throughout
- + Lifeshield protection for easy cleaning
- + Available in chrome and matt black
- + Lifetime Guarantee
- + Made In Britain

Corner Pivot Doors

Door Size	*Product Code	Adjustments (mm)	Dimensions (mm)					
		A	B	C	D	E	F	H
800mm	SNPCP80	775-795	635-655	585	137	32	18	102
900mm	SNPCP90	875-895	635-655	585	237	32	18	102
1000mm	SNPCP100	975-995	635-655	585	337	32	18	102
1200mm	SNPCP120	1175-1195	635-655	585	537	32	18	102

Door Height: 2000 mm excluding tray (2025mm Inc. Support Bar)

*When ordering matt black please add **MBK** to product codes



Support bar

Diagram

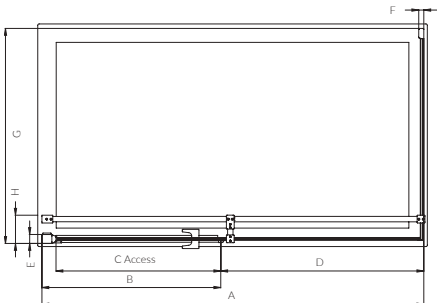

Side Panels

Panel Size	Product Code	Adjustments (mm)
		G
760mm	SNPC76	735-755
800mm	SNPC80	775-795
900mm	SNPC90	875-895



Chrome door handle

Pivot corner doors can be fitted to open either to the left or right by rotating the enclosure 180°



Chrome corner pivot door enclosure



Matt black corner pivot door enclosure

siona

Pivot recess doors

The semi-frameless siona pivot door features a barrel pivot mechanism and crystal clear seals throughout and includes corner and recess door options.

Combining the benefits of a fully framed enclosure with the aesthetic of frameless enclosures, the siona pivot door is perfect for medium to large bathrooms.

Features & Benefits

- + 2000mm high
- + 8mm toughened safety glass
- + Crystal clear seals
- + Barrel pivot hinge mechanism
- + Concealed fittings throughout
- + Lifeshield protection for easy cleaning
- + Available in chrome and matt black
- + Lifetime Guarantee
- + Made In Britain

Recess Pivot Doors

Door Size	*Product Code	Adjustments (mm)	Dimensions (mm)					
		A	B	C	D	E	F	G
800mm	SNPR80	765-805	635-655	585	137	32	18	130
900mm	SNPR90	865-905	635-655	585	257	32	18	130
1000mm	SNPR100	965-1005	635-655	585	357	32	18	130
1200mm	SNPR120	1165-1205	635-655	585	557	32	18	130
1400mm	SNPR140	1365-1405	635-655	585	757	32	18	130



Chrome door handle

Door Height: 2000 mm excluding tray (2025mm Inc. Support Bar)

*When ordering matt black please add **MBK** to product codes

Diagram

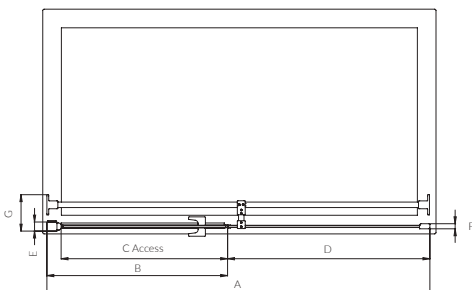

Pivot recess doors can be fitted to open either to the left or right by rotating the enclosure 180°



Support bar



Chrome recess pivot door enclosure



Matt black recess pivot door enclosure

siona

Sliding corner doors

The siona sliding door can be used to create corner or recess enclosures up to 1500mm wide, this stunning enclosure features a double roller for a smooth sliding action.

The siona sliding door can be installed to open either to the left or right and when installed with a Kudos connect2 tray, is the perfect solution for a medium to large bathroom space.

Features & Benefits

- + 2000mm high
- + 8mm toughened safety glass
- + Crystal clear seals
- + Double roller mechanism
- + Concealed fittings throughout
- + Suitable for corner, recess and 3 sided installations
- + Lifeshield protection for easy cleaning
- + Available in chrome and matt black
- + Lifetime Guarantee
- + Made In Britain

Corner Sliding Doors

Door Size	*Product Code	Adjustments (mm)	Dimensions (mm)			
		A	B	C	D	
1200mm	SNS120	1155-1195	430	513-533	18	
1400mm	SNS140	1355-1395	530	613-633	18	
1500mm	SNS150	1455-1495	530	713-733	18	

Door Height: 2000mm excluding tray (2025mm Inc. Support Bar)

*When ordering matt black please add **MBK** to product codes

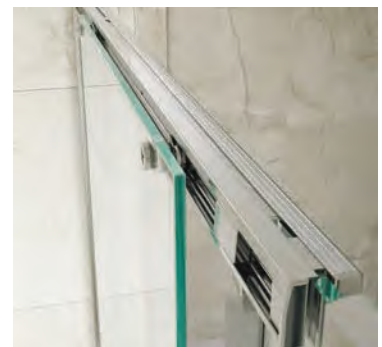

Sliding door mechanism

Diagram



Sliding corner doors can be fitted to open either to the left or right by rotating the enclosure 180°

Side Panels

Panel Size	Product Code	Adjustments (mm)
		E
760mm	SNSC76	725-745
800mm	SNSC80	765-785
900mm	SNSC90	865-885



Chrome door handle

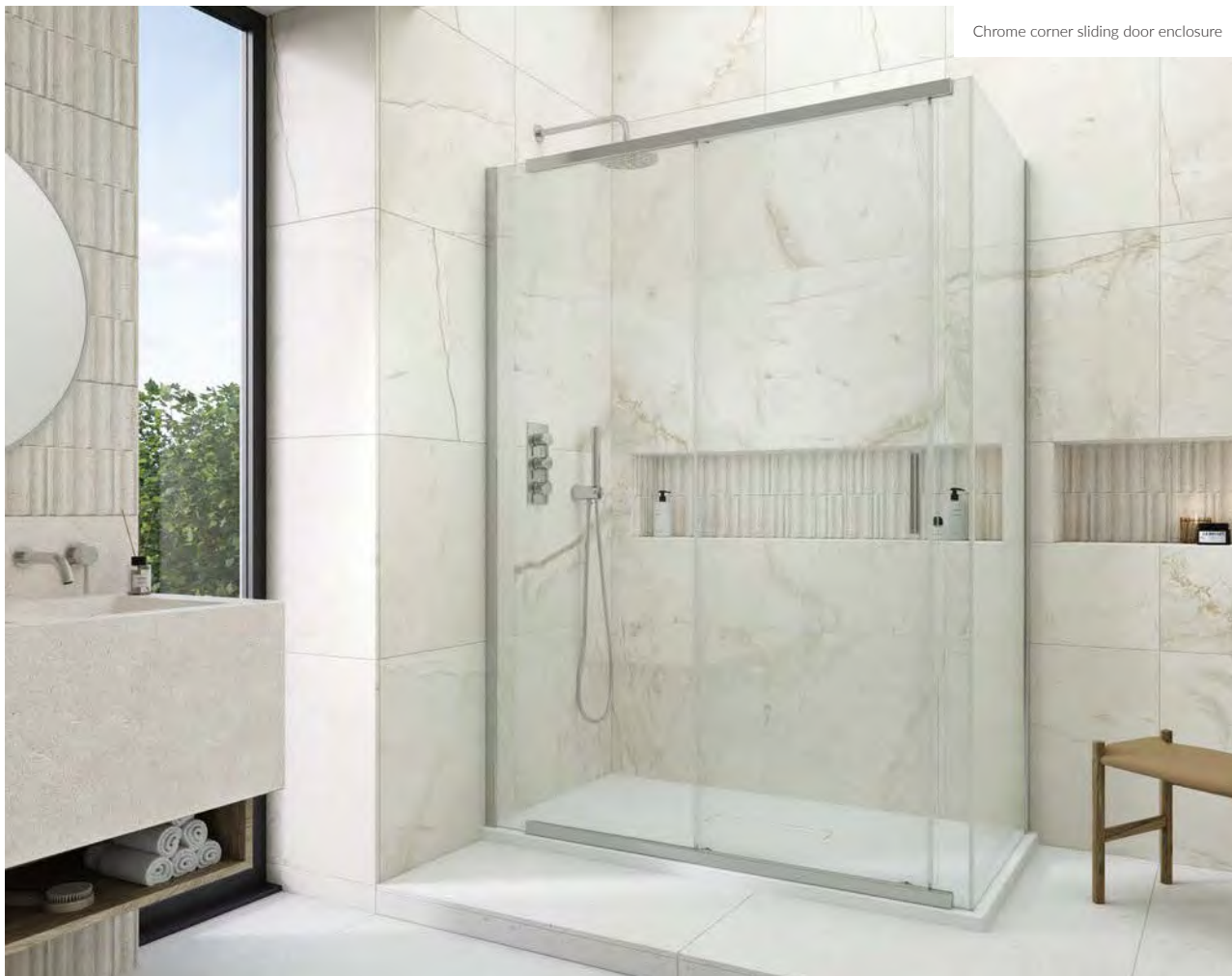

Chrome corner sliding door enclosure



Matt black corner sliding door enclosure

siona

Sliding recess doors

The siona sliding door can be used to create corner or recess enclosures up to 1500mm wide, this stunning enclosure features a double roller for a smooth sliding action.

The siona sliding door can be installed to open either to the left or right and, when installed with a Kudos connect2 tray, is the perfect solution for a medium to large bathroom space.

Features & Benefits

- + 2000mm high
- + 8mm toughened safety glass
- + Crystal clear seals
- + Double roller mechanism
- + Concealed fittings throughout
- + Suitable for corner, recess and 3 sided installations
- + Lifeshield protection for easy cleaning
- + Available in chrome and matt black
- + Lifetime Guarantee
- + Made In Britain

Recess Sliding Doors

Door Size	*Product Code	Adjustments (mm)	Dimensions (mm)			
		A	B	C	D	
1200mm	SNS120	1155-1195	430	513-533	18	
1400mm	SNS140	1355-1395	530	613-633	18	
1500mm	SNS150	1455-1495	530	713-733	18	

Door Height: 2000mm excluding tray (2025mm Inc. Support Bar)

*When ordering matt black please add **MBK** to product codes

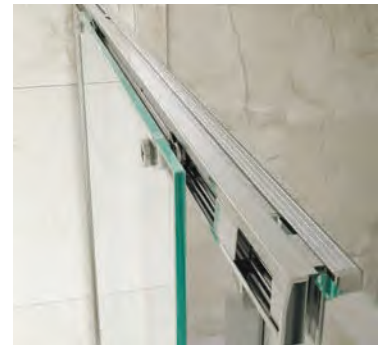

Sliding door mechanism

Diagram

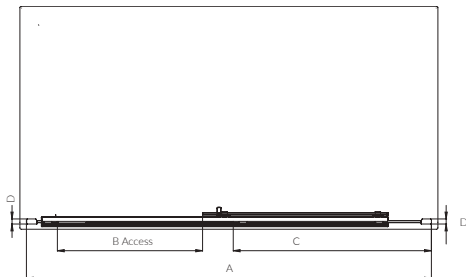

Sliding recess doors can be fitted to open either to the left or right by rotating the enclosure 180°



Chrome door handle

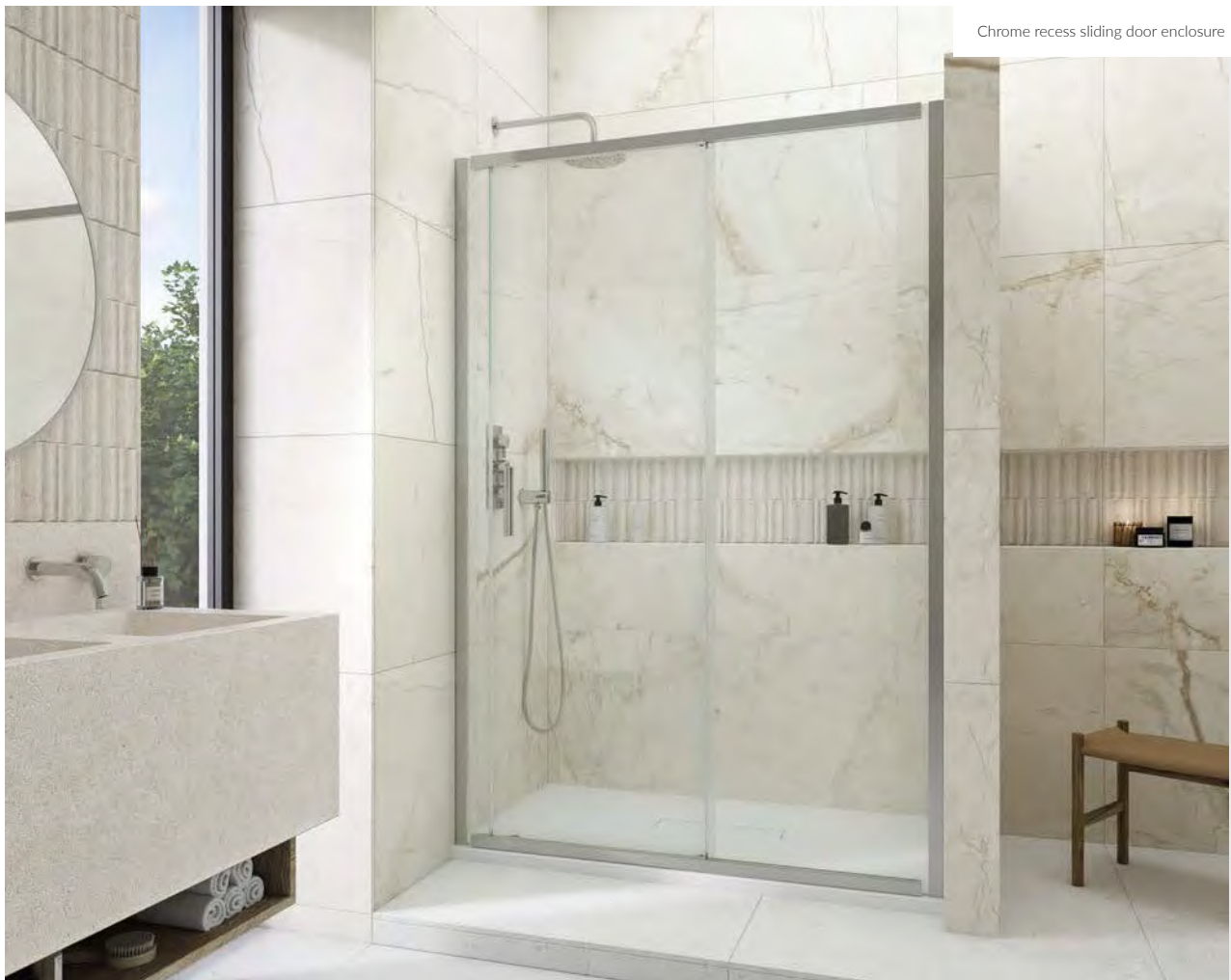

Chrome recess sliding door enclosure



Matt black recess sliding door enclosure





CORE COLLECTION

walk-in Enclosures

Versatile and fantastic value, Kudos walk-ins are easy to install and enable you to create the spa-like bathroom space that is unique to you whilst ensuring that it is practical without having to sacrifice on style.

Sleek and stylish, with a plethora of colour and size options, the ultimate and siona walk-in enclosures are backed by the Kudos Lifetime Guarantee and will complement and enhance every style of bathroom design.

Backed by the Kudos Lifetime Guarantee, the Kudos walk-in ranges complement and enhance every style of bathroom design.



*See website for details.

siona

Walk-in enclosures

Whether you're creating a minimalist spa-style bathroom or are looking to future proof your space with a low level, easy access, enclosure the Siona walk-in range represents the perfect solution.

Competitively priced and easy to install, this range features 8 panel sizes from 700-1400mm and is available in both chrome and matt black finishes.

Suitable for installation either on aqua4ma or a Kudos shower tray such as connect2, the siona walk-in range offers flexibility and gives you the opportunity to create the configuration that is perfect for your bathroom space.

Features & Benefits

- + 2000mm high
- + 8mm toughened safety glass
- + 8 panel sizes
- + 2 deflector options
- + Available in chrome and matt black
- + Can be used to create corner and recess configurations
- + LifeShield protection for easy cleaning
- + Lifetime Guarantee

Codes & Dimensions

Panel Sizes*	Product Code 8mm Glass
700mm Glass Panel	SNWPI70
760mm Glass Panel	SNWPI76
800mm Glass Panel	SNWPI80
900mm Glass Panel	SNWPI90
1000mm Glass Panel	SNWPI100
1100mm Glass Panel	SNWPI110
1200mm Glass Panel	SNWPI120
1400mm Glass Panel	SNWPI140
Glass to Glass Corner Seal	SNWPCS

*Sizes shown are nominal. All panels are undersized by 45mm to allow for tiling when fitting to shower trays. When choosing your panel size we recommend allowing access of approx. 500mm.

Note: Pack includes glass panel, wallpost, support bar and T piece.

Accessories	Product Code
Glass to Ceiling Stablisng Pack (600mm rail)	SNWPGC60
Angled Fixing Bracket (300mm)	SNWPGW30

*When ordering matt black please add **MBK** to product codes

Please note that whilst deflector panels will contain a significant amount of overspray, they are not intended to be watertight so some water may leave the showering area (particularly with smaller configurations)

Deflector Panels

Style	*Product Code	Deflector Length (mm)	Dimensions (mm)	
		A	B	C
Foldaway Deflector (0-180°)	SNFAD42	378	416	18
Hinged Deflector (90-270°)	SNHIND42	378	407	18

Foldaway Deflector

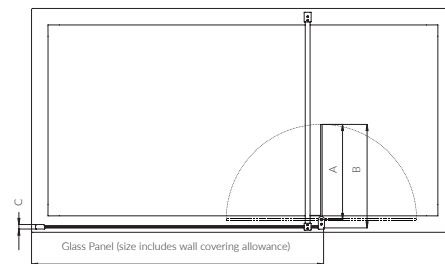

Hinged Deflector

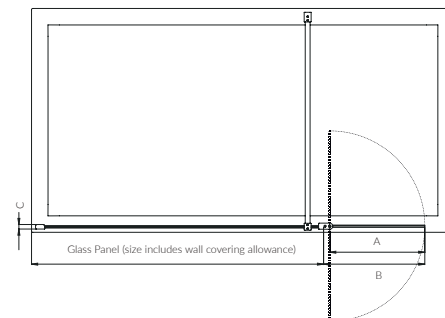

Chrome corner walk in enclosure



Matt black recess walk in enclosure with foldaway deflector



Ultimate bronze tinted glass with brushed brass wall post and front panel fixing kit



ultimate curved corner with flat side panel, wall post, L/H hinged deflector panel and concept bow fronted tray



ultimate

Walk-ins

The ultimate in versatility.

Stylishly minimalist and modern, yet classically elegant, Kudos ultimate walk-in enclosures complement and enhance every style of bathroom design.

Available in both 8mm and 10mm thicknesses, the ultimate range is as stylish as it is versatile. This stunning range is available in three core colour finishes and six 'to order' colours alongside colour glass options, this range really is the ultimate in versatility.

Features & Benefits

- + 13 panel sizes*
- + 3 curved 8mm panel sizes
- + 1950mm high (exc. fittings) 1985mm high (inc. fittings)
- + Toughened safety glass with Lifeshield easy clean coating
- + Choice of fittings to suit all situations
- + 4 deflector panel options
- + Available in 9 colour finishes
- + Coloured 10mm glass options available
- + Lifetime Guarantee
- + Made in Britain
- *10mm only, 11 8mm panel sizes

ultimate recess: 1 panel, 1 x matt black wall post, 1 x matt black front panel fixing kit,
1 x aqua4ma evolution centre waste deck



ultimate

Curved panel enclosures

These unique elegantly designed Bow Fronted walk-in enclosures are the perfect solution for smaller bathrooms or where wall space is restricted.

Combining 8mm curved toughened glass panels with Kudos Concept Bow Fronted shower trays, ultimate curved panel walk-in enclosures make an ideal bath replacement especially where a door or window position restricts the available depth of the showering area. Available in three sizes, to suit 1200mm, 1500mm, 1700mm curved trays measuring just 700mm at each end providing the bather with a generous showering area for comfort and enjoyment.

Features & Benefits:

- + 3 Panel sizes in 8mm (700mm, 1000mm, 1200mm) for 1200mm, 1500mm and 1700mm bow fronted trays
- + 1950mm high exc. fittings. 1985mm high (inc. fittings)
- + Glass to floor gasket to minimise silicone.
- + Easy fit dry-seal wall post, requiring no silicone
- + Available in a number of colour finishes
- + Lifeshield™ easy clean glass coating
- + Lifetime Guarantee
- + Made In Britain

ultimate curved corner with flat side panel, wall post, L/H hinged deflector panel and concept bow fronted tray



ultimate curved corner with flat side panel, wall post, L/H hinged deflector panel and concept bow fronted tray



ultimate

Flat panel walk-in enclosures

11 flat panel sizes in 8mm and 13 in 10mm toughened safety glass with Lifeshield™ easy clean coating, enable you to create virtually any configuration to suit your style and imagination. Kudos ultimate flat panel walk-in enclosures can be fitted to tiled floors or most standard shower trays, however, if fitting to a shower tray, for complete peace of mind we recommend using the stunning connect2.

Features & Benefits:

- + Lifeshield™ easy clean glass coating
- + 11 flat panel sizes in 8mm and 13 in 10mm
- + 1950mm high (exc. fittings) 1985mm high (inc. fittings)
- + Glass to floor gasket to minimise silicone
- + Easy fit dry-seal wall post, requiring no silicone
- + Available in a number of colour finishes



L/H Fold away deflector panel in 'closed' position



L/H Fold away deflector panel in 'open' position

ultimate recess 1x ultimate panel, 1x matt black wall post, 1x matt black stabilising arm and aqua4ma Evolution end waste deck

ultimate corner: 2 single panels, 1 wall post, 1 front panel fixing kit,
one fold away deflector panel on a connect2 tray.



ultimate walk-in: x2 glass panels, chrome, right hand hinged deflector panel, x2 chrome angle panel fixing kit and aqua4ma evolution centre waste deck



ultimate walk-through: single panel, matt black hinged deflector panel x 2, matt black front panel fixing kit x 2 and aqua4ma evolution centre waste deck



ultimate brushed brass recess: 1 panel, 1x wall post, 1x front panel fixing kit, 1x connect2 shower tray



ultimate

Roller deflector

Part of the ultimate range of walk-in enclosures the ultimate roller deflector is 500mm wide and is available in 4 colour finishes and both 8mm and 10mm clear glass options.

Retro-fittable* and treated with LifeShield for easy cleaning the roller deflector is designed to contain the majority of overspray and splashing within the showering area. Featuring a stylish finger pull the ultimate roller deflector is supplied with a trimmable runner meaning that it can be used on enclosures as small as 1200mm and up to (and including) enclosures as large as 2000mm.

The roller deflector isn't suitable for installation with an angled or ceiling fixing kit and you are required to order a front panel fixing kit when purchasing the roller deflector.

**existing enclosure must include a front panel fixing kit for this deflector to be installed retrospectively*

Features & Benefits

- + 1985mm (including fittings) high
- + 500mm wide
- + Available in 8mm and 10mm toughened safety glass options
- + Retro-fittable
- + Can be used to create corner or recess options
- + Available in chrome, matt black, brushed brass and brushed nickel
- + Can be installed to open either to the left or right
- + Treated with Lifeshield for easy cleaning
- + Lifetime Guarantee
- + Made In Britain

ultimate recess: matt black enclosure with a roller deflector on a connect2 tray



Ultimate deflector panels

Deflector Panels

Designed to contain the majority of over-spray and splashing within the showering area, Kudos ultimate deflector panels are available in three styles, each option is able to be retro-fitted and can be added at a later date if required.

Enjoy the pleasure and appearance of a walk-in shower even where space is at a premium. With the ability to fit a deflector panel it is now possible to create a functional and stunning enclosure even as small as 1200mm*.

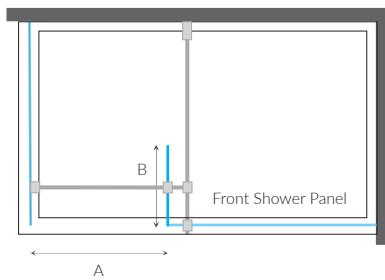

Fixed Deflector Panel:

Supplied with fixings to connect to standard fixing kit recess or corner. This 255mm fixed deflector panel provides a 90° angled barrier to prevent splashing outside of the showering area.

Not suitable for use with angled or ceiling fixing kit. Not for use with curved panels

A = Rec min access 500mm B = 265mm

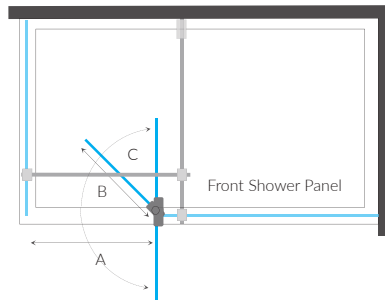

Hinged Deflector Panel:

Available in 300 and 400mm widths in both 8 & 10mm glass thickness, the hinged deflector rotates through 180° for easy access. Featuring heavy duty hinges with crystal clear seals for minimalist appearance. Available in both 8 & 10mm glass thickness and featuring heavy duty hinges and crystal clear vertical seal.

Suitable for use with flat and curved panel enclosures and all ultimate fixing kits

A = Rec min access 500mm B = 300mm or 400mm C = 180° rotation for easy access

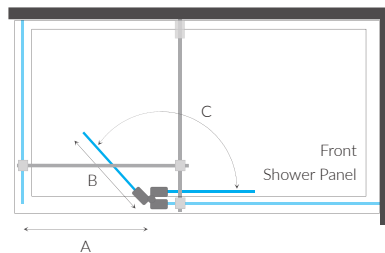

Fold-Away Hinged Deflector Panel:

Designed to fit neatly behind the front panel when not in use, the 300mm Fold-Away deflector panel stops at a 45° angle to the front panel when in use to provide the optimum protection from over-spray. Available in both 8 & 10mm glass thickness.

Suitable for use with flat panel enclosures and all ultimate fixing kits

A = Rec min access 500mm B = 300mm
C = 135° rotation stops at optimum position for maximum overspray protection

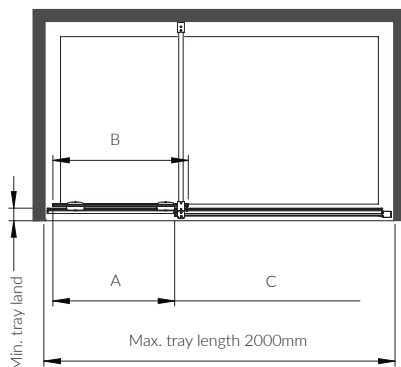

Roller Deflector Panel:

Designed to fit neatly behind the front panel when not in use, the ultimate roller deflector provides maximum coverage to minimise overspray from your walk-in enclosure. The integrated, full length, threshold strip provides further protection. Available in both 8mm and 10mm glass thicknesses.

Suitable for use only with flat panel enclosures and the ultimate front panel fixing kit.

A = Rec min access 500mm B = 300mm
C = Adjustable stops allow for max 485mm overhang

Note: All ultimate Hinged Deflector Panels are handed please suffix codes with LH or RH. All illustrations show Right Hand option.

*Please note that whilst deflector panels will contain a significant amount of overspray they are not intended to be watertight so some water may leave the showering area (particularly with smaller configurations).

Ultimate10 enclosure, matt black wallpost with smoke grey glass



Ultimate smoked glass with satin stripe, matt black wall post and front panel fixing kit



ultimate

10mm coloured glass

Creating a unique walk-in enclosure could not be easier with the colour 10mm options that are included in the ultimate range.

These stunning panels are available in bronze tint, smoked, satin (frosted) and smoked with satin modesty stripe and in 5 panel sizes. Available as standard in chrome/ matt black/ brushed brass and brushed nickel finishes as well as five additional colour finishes including white, brushed bronze and gun metal – let your imagination run wild and create the ultimate showering space with the Kudos ultimate wet-room panel collection.

Features & Benefits:

- + 4 glass colour finishes
- + 5 flat panel sizes
- + Fold away deflector panel
- + 1950mm high (exc. Fittings, 1985mm inc. fittings)
- + Available in 9 colour finishes
- + Lifeshield easy clean glass coating
- + Easy fit dry-seal wall post
- + Lifetime Guarantee
- + Made In Britain

ultimate brushed brass recess: 1 panel, 1x wall post, 1x front panel fixing kit, 1x connect2 shower tray

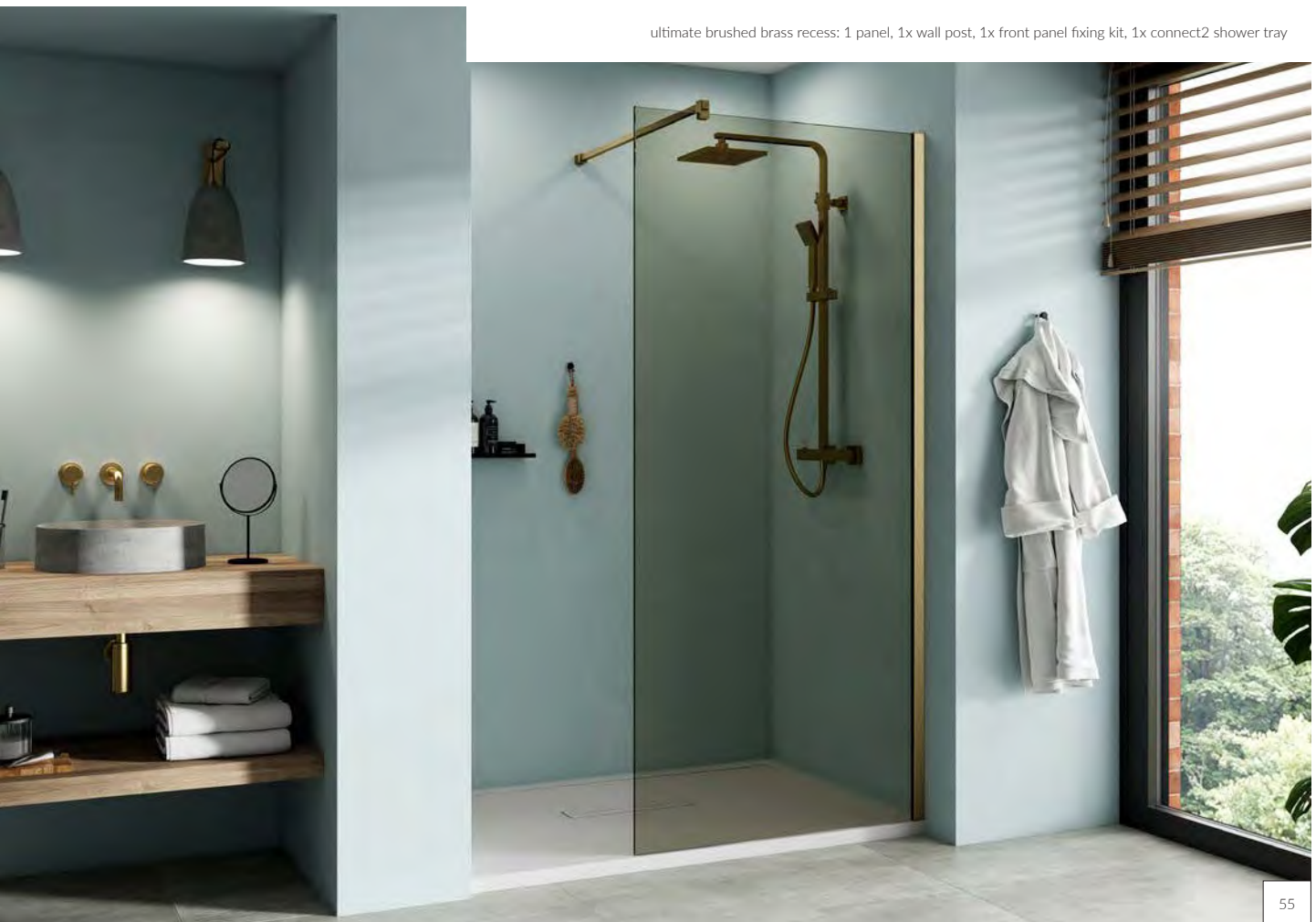

ultimate10

Mirrored décor panel

Part of the ultimate 10mm collection, the mirrored décor panel is a great way of incorporating a full length mirror into your design. Creating the illusion of space whilst being practical.

Features & Benefits:

- + Compatible with 10mm ultimate panels
- + 1985mm high (including fittings)
- + 400mm wide
- + Lifeshield protection for easy cleaning
- + Lifetime Guarantee

ultimate 10mm walk-in wetroom panel with 400mm mirrored décor panel, brushed brass wall post, front panel fixing kit and interconnector



ultimate¹⁰

Interconnector

Designed to be used alongside ultimate 10mm wet room panel range, the interconnector enables you to connect two panels together allowing you to create either a larger enclosure (without having to worry about the weight of the glass) or to incorporate some of our coloured glass or even our mirrored décor panel into your design.

The interconnector works as a glass clamp with a watertight seal to connect two pieces of ultimate 10mm glass making installing larger enclosures much easier. The interconnector also means that you could use contrasting glass panels from our 10mm range to create a unique shower enclosure.

Features & Benefits:

- + To be used with ultimate 10mm wet room panels
- + 1985mm high (including fittings)
- + Available in 9 colour finishes
- + Covered by the Kudos Lifetime Guarantee
- + Lifetime Guarantee
- + Made In Britain

Brushed brass interconnector and mirrored decor panel

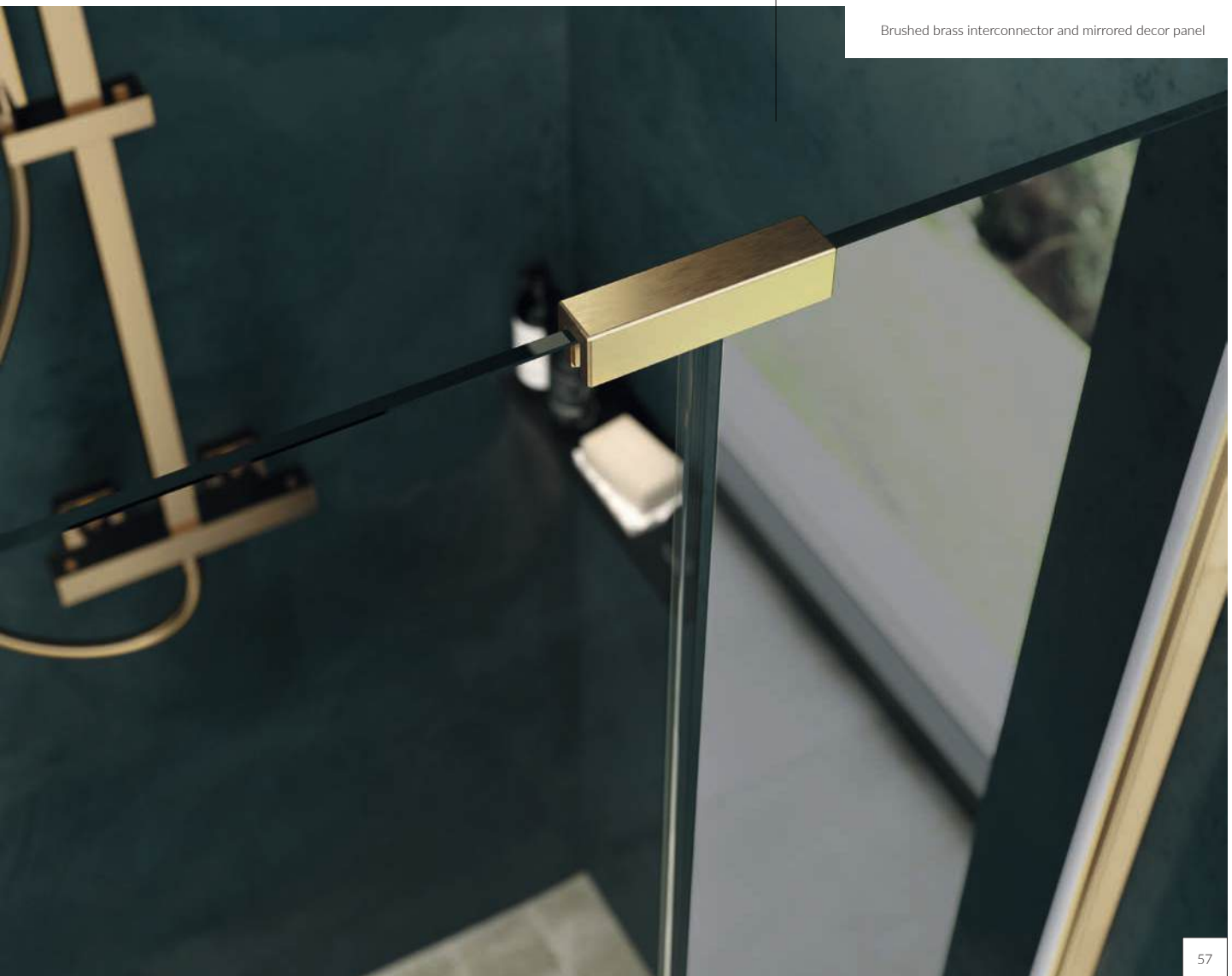

ultimate¹⁰

10mm glass to glass corner post

The ultimate glass to glass corner post allows you to choose between either a minimalist approach (using the ultimate corner to corner seal) or a more traditional look and feel using the glass to glass corner post.

Features & Benefits:

- + To be used with ultimate 10mm wet room panels
- + 1985mm high (including fittings)
- + Available in 9 colour finishes
- + Lifetime Guarantee
- + Made In Britain

Brushed brass glass to glass corner post

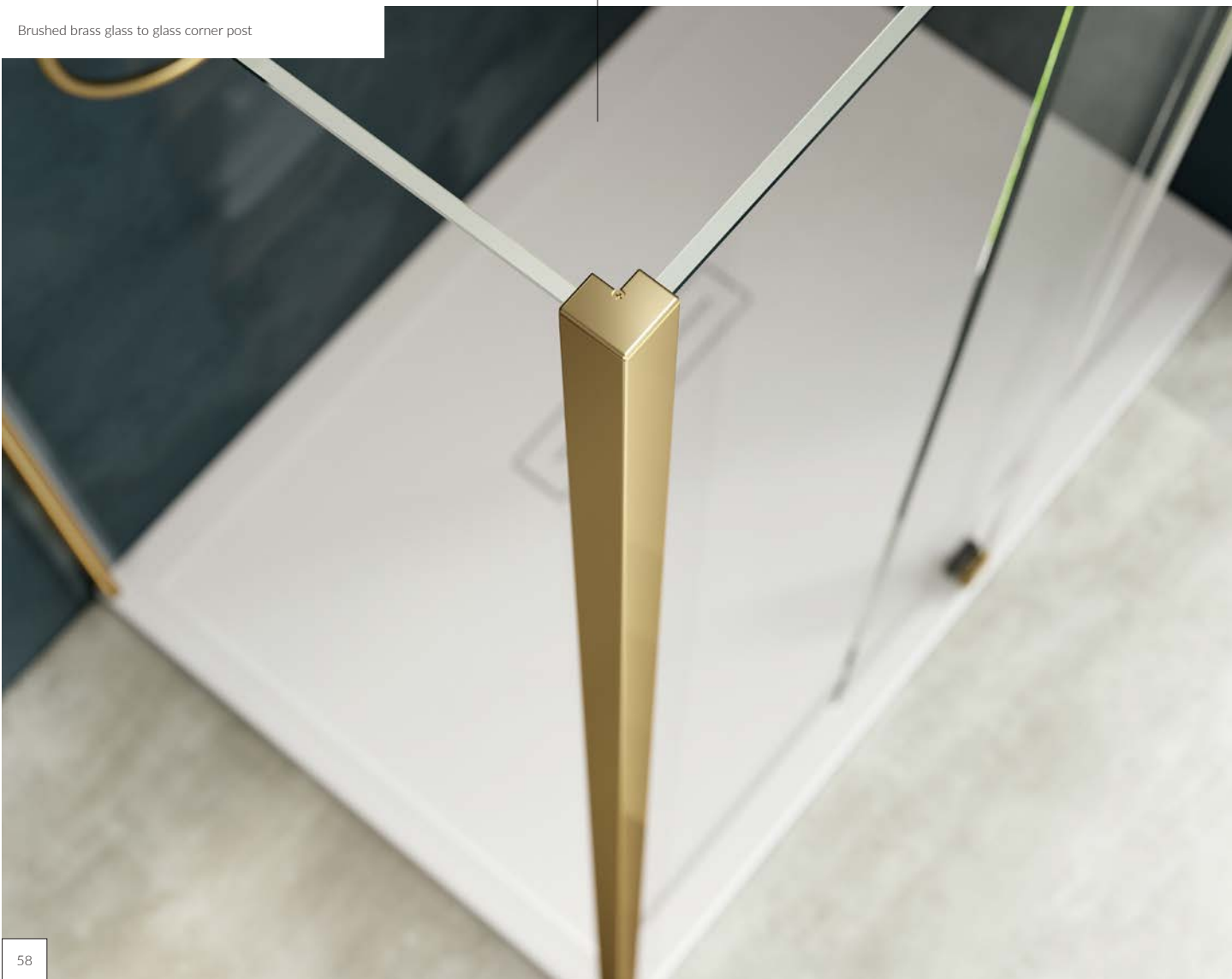

Ultimate fixing kits and colour finishes.

Fixing Kits

To secure your shower panel we offer a number of fixing options. For maximum stability we recommend the Standard fixing kit, available for both front panel and side panels. However, if it is not possible to use this style of fixing, we also offer an angled fixing kit in 2 sizes or a glass to ceiling support which can be cut to the desired length.



Standard Fixing Kits

Shown: Front panel fixing kit with side panel fixing kit. Each stabilising bar is 1000mm long and can be cut to suit. A 1500mm front panel kit is also available.

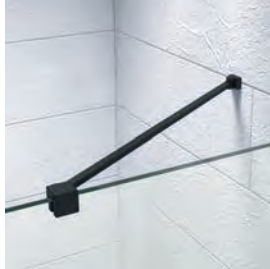

Angled Fixing Kit

Available in 300mm or 500mm options.



Ceiling Fixing Kit

Ceiling fixing bar is 600mm long and can be cut to suit ceiling height.

See page 60 for suitability of fixings based on the configuration of your walk-in enclosure.

Colour Finishes

Kudos ultimate fittings are available in Chrome/Silver, Matt Black, Brushed Nickel and Brushed Brass. In addition Polished Gold, Polished Bronze, Brushed Bronze, Gun Metal and White are available to special order.

Standard Colour Finishes

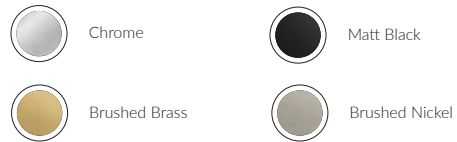

Special Order Colour Finishes*

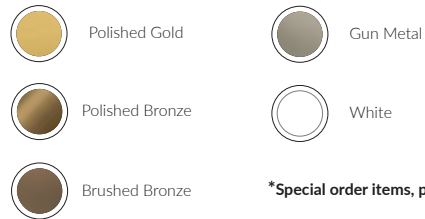

*Special order items, please allow 8 weeks

ultimate 10mm over bath panels also available see page 66



Create the walk-in that is perfect for your bathroom.

Flat Panel Configurations

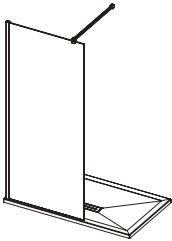

Recessed
 1 x Glass Panel
 1 x Wall Post
 1 x Front Panel Fixing Kit*
 *Standard, Ceiling or Angled

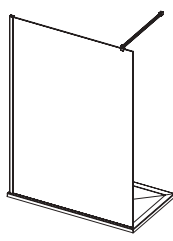

Open Ended
 1 x Glass Panel
 1 x Wall Post
 1 x Front Panel Fixing Kit*
 *Standard, Ceiling or Angled

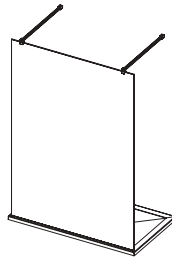

Walk Through
 1 x Glass Panel
 2 x Front Panel Fixing Kits*
 *Standard

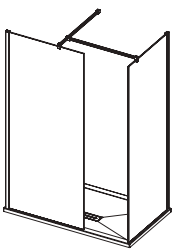

Corner
 1 x Glass Panel (Front)
 1 x Glass Panel (Side)
 2 x Wall Posts
 1 x Front Panel Fixing Kit*
 1 x Side Panel Fixing Kit*
 *Standard, Ceiling or Angled

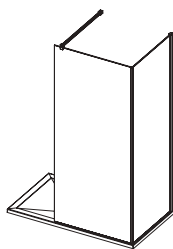

Corner (glass to glass)
 1 x Glass Panel (Front)
 1 x Glass Panel (Side)
 1 x Wall Post
 1 x Front Panel Fixing Kit*
 1 x Corner Seal
 *Standard, Ceiling or Angled

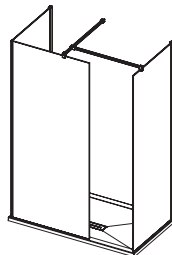

Three Sided
 1 x Glass Panel (Front)
 2 x Glass Panels (Side)
 2 x Wall Posts
 1 x Front Panel Fixing Kit*
 1 x Side Panel Fixing Kit*
 1 x Corner Seal
 *Standard, Ceiling or Angled



Roller Deflector (500mm)
 1 x Glass Panel (8/10mm)
 1 x Wall post (10WPK)
 1x Ultimate Roller (8/10mm)
 1 x Front Panel Fixing kit (10WPFPFK)



Interconnector**
 2 x Glass Panel
 1x Wall post
 1 x Interconnector

**Available in 10mm only

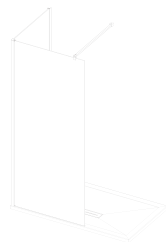

Glass to Glass Corner Post**
 2 x Glass Panel
 1x Wall post
 1 x Glass to glass corner post
 1x Front panel fixing kit

**Available in 10mm only

Flat Panels

Codes & Dimensions

Panel Sizes*	Product Code 8mm Glass	Product Code 10mm Glass
200mm Glass Panel	-	10WP200
300mm Glass Panel	-	10WP300
400mm Glass Panel	5WP400	10WP400
500mm Glass Panel	5WP500	10WP500
600mm Glass Panel	5WP600	10WP600
700mm Glass Panel	5WP700	10WP700
760mm Glass Panel	5WP760	10WP760
800mm Glass Panel	5WP800	10WP800
900mm Glass Panel	5WP900	10WP900
1000mm Glass Panel	5WP1000	10WP1000
1100mm Glass Panel	5WP1100	10WP1100
1200mm Glass Panel	5WP1200	10WP1200
1400mm Glass Panel	5WP1400	10WP1400
400mm Mirrored Decor Panel	-	10WPM400
Glass to Glass Corner Seal	5WPCS	10WPCS

*Sizes shown are nominal. All panels are undersized by 45mm to allow for tiling when fitting to shower trays. When choosing your panel size we recommend allowing access of approx. 500mm.

Ultimate flat panel walk-in enclosures can be fitted to tiled floors or most standard shower trays, however if fitting to a shower tray for complete peace of mind we recommend using a Kudos Kstone or the stunning connect2.

Fixing Kits

Description	Silver/Chrome *Product Code	Matt Black Product Code	Brushed Brass Product Code	Brushed Nickel Product Code
Wall Post for Flat Glass Panels	10WPK	10WPKMBK	10WPKBRG	10WPKBRN
Wall Post for SE Curved Glass Panels	10WPKCV	10WPKCVMBK	10WPKCVBRG	10WPKCVBRN
8mm Glass to Glass Corner Seal	5WPCS	-	-	-
10mm Glass to Glass Corner Seal	10WPCS	-	-	-
Glass to Glass Corner Post	10WPKCP	10WPKCPMBK	10WPKCPBRG	10WPKCPBRN
10mm Interconnector (Includes H Seal)	10WPIC	10WPICMBK	10WPICBRG	10WPICBRN
Front Panel Fixing Kit Standard (1000mm)	10WPFPFK	10WPFPFKMBK	10WPFPFKBRG	10WPFPFKBRN
Front Panel Fixing Kit (1500mm)	10WPFPFK150	10WPFPFK150MBK	10WPFPFK150BRG	10WPFPFK150BRN
Side Panel Fixing Kit	10WPSPFK	10WPSPFKMBK	10WPSPFKBRG	10WPSPFKBRN
Glass to Ceiling Fixing Kit	10WPGC	10WPGCMBK	10WPGCBRG	10WPGCBRN
Angled Fixing Kit (300mm)	10WPGW30	10WPGW30MBK	10WPGW30BRG	10WPGW30BRN
**Angled Fixing Kit (500mm)	10WPGW50	10WPGW50MBK	-	-

Deflector Panels

Description	Silver/Chrome *Product Code	Matt Black Product Code	Brushed Brass Product Code	Brushed Nickel Product Code
**Fixed Deflector Panel 8mm Glass	5WPDEFP	5WPDEFPMBK	-	-
**Hinged Deflector Panel (300mm) 8mm Glass †	5WPHINDP	5WPHINDPMBK	5WPHINDPBRG	5WPHINDPBRN
**Hinged Deflector Panel (400mm) 8mm Glass †	5WPHINDP400	5WPHINDP400MBK	5WPHINDP400BRG	5WPHINDP400BRN
Fold Away Deflector Panel (300mm) 8mm Glass †	5WPFADP	5WPFADPMBK	5WPFADPBRG	5WPFADPBRN
**Fixed Deflector Panel 10mm Glass	10WPDEFP	10WPDEFPMBK	-	-
**Hinged Deflector Panel (300mm) 10mm Glass †	10WPHINDP	10WPHINDPMBK	10WPHINDPBRG	10WPHINDPBRN
**Hinged Deflector Panel (400mm) 10mm Glass †	10WPHINDP400	10WPHINDP400MBK	10WPHINDP400BRG	10WPHINDP400BRN
Fold Away Deflector Panel (300mm) 10mm Glass †	10WPFADP	10WPFADPMBK	10WPFADPBRG	10WPFADPBRN
8mm 500mm Roller Deflector	5WPRDP500	5WPRDP500MBK	5WPRDP500BRG	5WPRDP500BRN
10mm 500mm Roller Deflector	10WPRDP500	10WPRDP500MBK	10WPRDP500BRG	10WPRDP500BRN

* Please add the following codes to your product code when ordering a colour option:

Polished Gold (PG), Polished Bronze (PB), Brushed Bronze (BRB), Brushed Nickel (BRN), Gun Metal (GM) and White (WH).

All are special order items, please allow 8 weeks

** Only available in Chrome and Matt Black

† Hinged and Fold-away deflector panels are handed please suffix codes with LH or RH

Ultimate 10mm coloured glass finishes and deflector panels

Coloured 10mm Glass Panels

4 colour finishes in 5 panel sizes, these 10mm wet room panels will make a statement in any bathroom.

Features & Benefits:

- + 10mm toughened safety glass
- + 1985mm high (including fixings)
- + Treated with LifeShield for easy cleaning
- + Foldaway deflectors available
- + Covered by the Kudos Lifetime guarantee
- + Made in Britain

Width	Product Codes			
	Bronze Tint	Smoke Grey	Satin (Frosted)	Smoke Grey With Satin Frosted Band
700mm	10WP700BG	10WP700GR	10WP700SA	10WP700GRSA
800mm	10WP800BG	10WP800GR	10WP800SA	10WP800GRSA
900mm	10WP900BG	10WP900GR	10WP900SA	10WP900GRSA
1000mm	10WP1000BG	10WP1000GR	10WP1000SA	10WP1000GRSA
1200mm	10WP1200BG	10WP1200GR	10WP1200SA	10WP1200GRSA

Coloured 10mm Fold Away Deflector Panels

Kudos ultimate fittings are available in Chrome/Silver, Matt Black, Brushed Nickel and Brushed Brass. In addition Polished Gold, Polished Bronze, Brushed Bronze, Gun Metal and White are available to special order*.

Features & Benefits:

- + 10mm toughened safety glass
- + 1985mm high (including fixings)
- + Treated with LifeShield for easy cleaning
- + Special order item, please allow upto 4 weeks for delivery.
- + Covered by the Kudos Lifetime guarantee
- + Made in Britain

Glass Colour Finishes

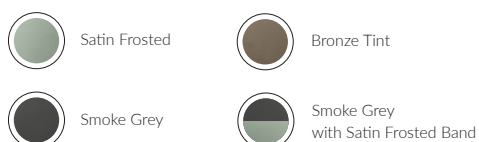

Deflector Colours	*Product Codes	
	10mm Fold Away Deflector Panel (Left Hand)	10mm Fold Away Deflector Panel (Right Hand)
Chrome With Satin (Frosted) Glass	10WPFADPLHSA	10WPFADPRHSA
Chrome With Smoked Grey Glass	10WPFADPLHGR	10WPFADPRHGR
Chrome With Bronze Tint Glass	10WPFADPLHGB	10WPFADPRHGB
Chrome With Smoked Grey & Satin (Frosted Band Glass	10WPFADPLHGRSA	10WPFADPRHGRSA
Matt Black With Satin (Frosted) Glass	10WPFADPLHSAMBK	10WPFADPRHSAMBK
Matt Black With Smoked Grey Glass	10WPFADPLHGMBK	10WPFADPRHGMBK
Matt Black With Smoked Grey & Satin (Frosted) Band Glass	10WPFADPLHGRSAMBK	10WPFADPRHGRSAMBK
Brushed Brass With Bronze Tint Glass	10WPFADPLHGBBRG	10WPFADPRHGBBRG

* To order special colour finishes add the colour suffix to the code. eg 10WPFADPLHGBBRB Polished Gold (PG), Polished Bronze (PB), Brushed Bronze (BRB), Gun Metal (GM) and White (WH).

Curved Panel Configurations

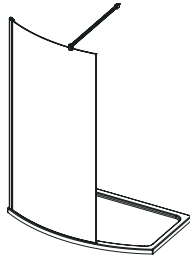

Recessed

- 1 x Curved Glass Panel
- 1 x Wall Post
- 1 x Standard Fixing Kit*

*Standard, Ceiling or Angled

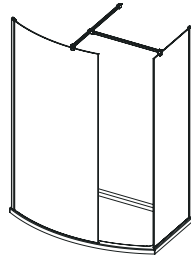

† Corner

- 1 x Curved Glass Panel
- 2 x Wall Posts
- 1 x Flat Glass Panel
- 1 x Standard Front Panel Fxing Kit**
- 1 x Side Panel Fixing Kit

*Standard, Ceiling or Angled

† For corner enclosures on a bowed front tray, use a standard 700m flat panel for the side panel.

Curved Panels

Codes & Dimensions

Panel Sizes*	Product Code
700mm Curved Panel (for 1200mm tray)	5WPCV700
1000mm Curved Panel (for 1500mm tray)	5WPCV1000
1200mm Curved Panel (for 1700mm tray)	5WPCV1200

Add 700mm flat panel to create a corner enclosure

Shower Panels for Space Efficient Enclosures (8mm only) **

*Sizes shown are nominal. All panels are undersized by 45mm to allow for tiling when fitting to shower trays. When choosing your panel size we recommend allowing access of approx. 500mm.

**Designed to fit a dedicated Bowed Fronted concept tray. Ultimate curved panels can be fitted direct to a tiled floor, however unless the wet floor area is shaped to match the curve of the panel drainage may be impaired

Fittings required for the SE enclosures, with the exception of the wall post, are the same as those shown for the equivalent flat panel enclosures.

Shower Trays for Curved Panel Enclosures

Shower Tray Codes & Dimensions

Tray Sizes	Standard High Gloss Product Code	SR (Slip Resistant) Product Code	Dimensions (mm)				
			A	B	C	D	E
1200mm x 700mm	DB120W	DB120WSR	1200	850	700	600	677
1500mm x 700mm	DB150W	DB150WSR	1500	888	700	750	714
1700mm x 700mm	DB170W	DB170WSR	1685	910	700	843	737

Overhead Diagrams

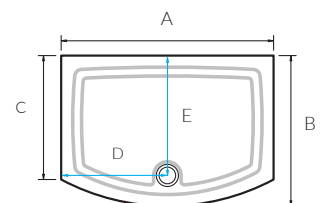

Kudos Concept Bow Fronted shower trays

Manufactured from an Acrylic capped ABS skin with a structured resin bonded stone filler. All sizes are available in a high gloss finish or with the new Kudos SR slip resistant matt finish.





CORE COLLECTION

bathscreens & Over-bath

Over-bath showering has long been considered a compromise of practicality over style and performance, but not anymore. The over-bath screen collection by Kudos means that making such a compromise is a thing of the past.

Kudos has been making high quality showering products for the last 20 years, hand-assembled using the best materials, our stunning collection of over-bath panels is designed to complement your bathroom space. All screens and panels are treated with Lifeshield glass protection for easy cleaning and are covered by the Kudos Lifetime guarantee.

The Kudos over-bath showering collection features two distinct ranges: the ultimate 10mm and inspire over-bath.



*See website for details.

ultimate¹⁰

Over-bath panels

Based on the Kudos ultimate walk-in shower enclosure system, ultimate fixed over-bath offer a simple yet elegant solution to over-bath showering. Available in 4 panel sizes in stunning 10mm toughened safety glass with Lifeshield™ coating and a choice of fixings, you can create combinations to suit virtually all situations. Available in a number of colour finishes.

A retro-fit Foldaway deflector panel allows for smaller front panels to be fitted to give maximum access to the bath whilst ensuring that when showering the spray is contained within the bathing area.

Features & Benefits:

- + Lifetime Guarantee
- + 10mm Toughened safety glass with Lifeshield™ protection
- + Adjustment for out of true walls
- + Available in a number of colour finishes

800mm panel, L/H fold away deflector panel, front panel fixing kit and wall post



800mm panel, 700mm panel, L/H fold away deflector panel, front panel fixing kit and wall post



A flexible, innovative, approach to over-bath showering



800mm panel, 700mm panel, L/H fold away deflector panel, front panel fixing kit and wall post

Foldaway deflector panels

The ultimate over-bath foldaway deflector panel when in use helps keep water inside the bath and when not in use folds neatly behind the front panel leaving access to the bath.



Colour Finishes

Kudos ultimate fittings are available in chrome/ silver, matt black and brushed brass, in addition brushed nickel and polished gold are available to special order.

Standard Colour Finishes



Special Order Colour Finishes*



*Special order items, please allow 8 weeks

Glass Panels

*Description	Product Code
700mm x 1600mm (10mm Glass Panel)	10BSWP700
750mm x 1600mm (10mm Glass Panel)	10BSWP750
800mm x 1600mm (10mm Glass Panel)	10BSWP800
900mm x 1600mm (10mm Glass Panel)	10BSWP900

*Sizes shown are nominal.

All panels are undersized by 45mm to allow for tiling

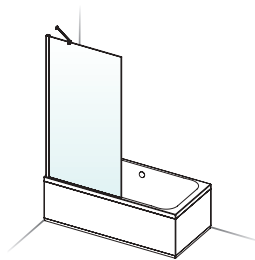

Single Panel

- 1 x Glass Panel
- 1 x Wall Post
- 1 x Front Panel Fixing Kit*

*Standard, Ceiling or Angled

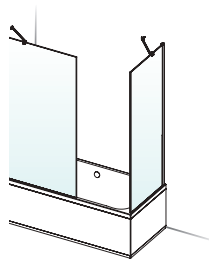

Corner

- 1 x Glass Panel (Front)
- 1 x Glass Panel (End)
- 2 x Wall Post
- 1 x Front Panel Fixing Kit*
- 1 x Side Panel Fixing Kit*

*Standard, Ceiling or Angled

Configurations

Illustrations show some of the configurations possible with the Kudos ultimate over-bath shower panel system. Each option shows the components required, to which a foldaway deflector kit can be added.

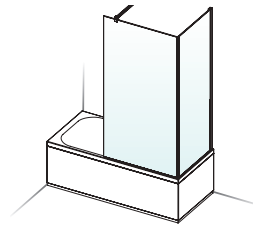

Corner (glass to glass)

- 1 x Glass Panel (Front)
- 1 x Glass Panel (End)
- 1 x Wall Post
- 1 x Front Panel Fixing Kit*
- 1 x Corner Seal

*Standard, or Ceiling

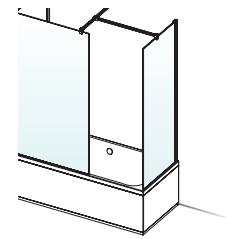

Three Sided

- 1 x Glass Panel (Front)
- 2 x Glass Panels (End)
- 2 x Wall Posts
- 1 x Front Panel Fixing Kit*
- 1 x Side Panel Fixing Kit*
- 1 x Corner Seal

*Standard, or Ceiling

Fixings & Deflector Panels

Codes & Dimensions

Description	Silver/Chrome Product Code	Matt Black Product Code	Brushed Brass Product Code	Brushed Nickel Product Code	Polished Gold Product Code
Wall Post	10BSBSWPK	10BSBSWPKMBK	10BSBSWPK BRG	10BSBSWPK BRN	10BSBSWPK PG
Front Panel Fixing Kit	10WPFPFK	10WPFPFKMBK	10WPFPFKBRG	10WPFPFKBRN	10WPFPFKPG
Side Panel Fixing Kit	10WPSPFK	10WPSPFKMBK	10WPSPFKBRG	10WPSPFKBRN	10WPSPFKPG
300mm Angled Fixing Kit	10WPGW30	10WPGW30MBK	10WPGW30BRG	10WPGW30BRN	10WPGW30PG
Glass to Ceiling Fixing Kit	10WPGC	10WPGCMBK	10WPGCBRG	10WPGCBRN	10WPGCPG
Glass to Glass Corner Seal	10BSWPCS	-	-	-	-
Foldaway Hinged Deflector Kit (Left Hand)*	10BSWPFADPLH	10BSWPFADPLHMBK	10BSWPFADPLHBRG	10BSWPFADPLHBRN	10BSWPFADPLHPG
Foldaway Hinged Deflector Kit (Right Hand)*	10BSWPFADPRH	10BSWPFADPRHMBK	10BSWPFADPRHBRG	10BSWPFADPRHBRN	10BSWPFADPRHPG

* Deflectors are handed by which side the hinges are located. Refer to pages 53 for more information

Matt black inspire left hand two panel in-fold bathscreen

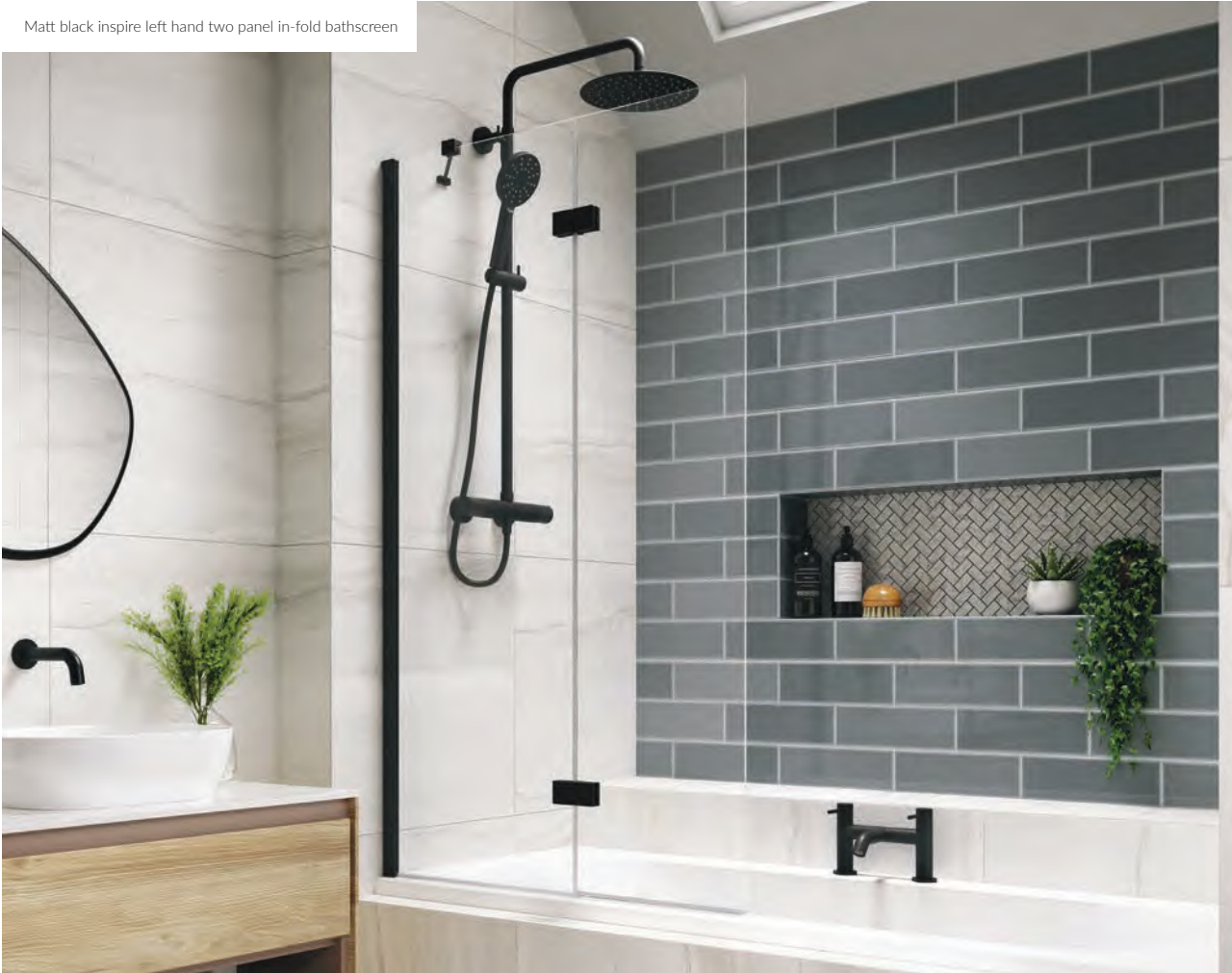

Chrome inspire left hand single panel bathscreen

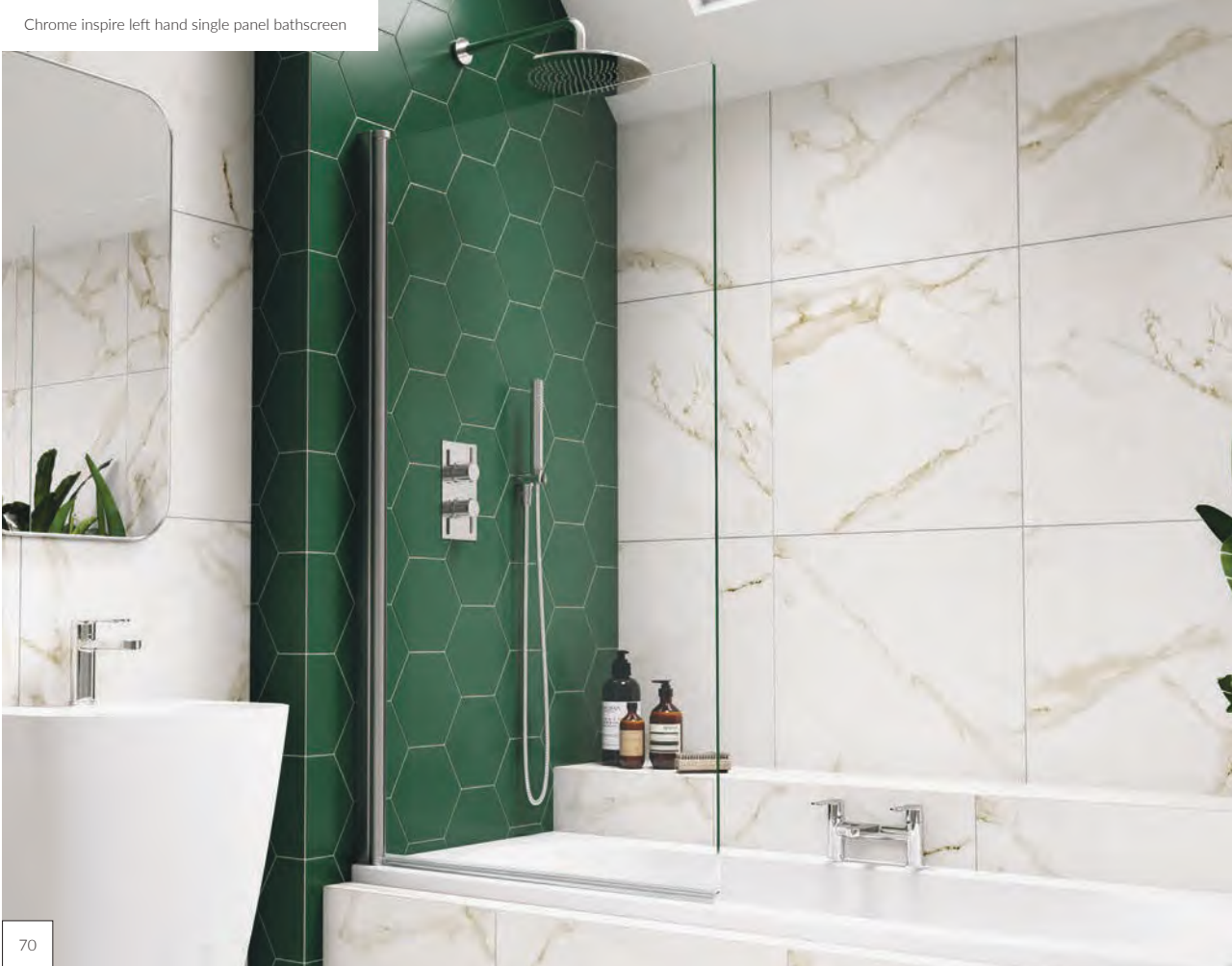

inspire

Bathscreen collection

Characterised by minimalist frameless design and innovative technologies including click-to-lock hinges to hold your screen in place and our unique SmartSeal Technology, available in single, two, three and four panel options. Featuring toughened safety glass throughout, our 6mm range is now available in either a chrome, matt black or brushed brass finish.

Features & Benefits

- + 6mm or 8mm glass options
- + Reversible for left or right hand fixing
- + SmartSeal technology
- + Lifetime Guarantee
- + Toughened safety glass with Lifeshield™ protection
- + Adjustment for out of true walls
- + 3 colour finishes*
- + Made In Britain

*Selected 6mm product only



Brushed brass right hand single panel bathscreen with towel rail

inspire

Single panel screens

Our Single Panel Bath Screens are larger than average, measuring 1500mm high and 850mm wide, to provide a more generous showering area.

For added comfort and convenience, Single Panel Bath Screens are available with an integrated rail so you can keep your towel conveniently within reach.

SmartSeal Technology incorporates integrated mouldings and twin element seals, delivering the ultimate shower protection.

Features & Benefits:

- + 6mm or 8mm glass options
- + Reversible for left or right hand fixing
- + Optional towel rail
- + SmartSeal technology
- + Lifetime Guarantee
- + Toughened safety glass with Lifeshield™ protection
- + Adjustment for out of true walls
- + 3 colour finishes*
- + Made In Britain

*6mm glass only

Codes & Demsions

Bath Screens	Chrome Product Code	Matt Black Product Code	Brushed Brass Product Code
Single Panel 6 mm	3BASC6NHS	3BASC6NHSMBK	3BASC6NHBRG
Single Panel 6 mm including towel rail	3BASC6S	3BASC6SMBK	3BASC6BRG
Single Panel 8 mm	3BASC8NHS	-	-
Single Panel 8 mm including towel rail	3BASC8S	-	-

Note: Kudos Bath screens are designed to fit on most standard straight edge baths. For best performance and water retention all fixed and moving panels should be parallel to the inner edge of the bath.

Overhead Diagram

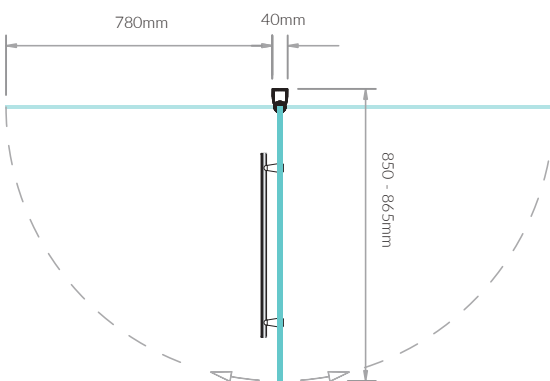

Dimensions: H: 1500mm x W: 850mm

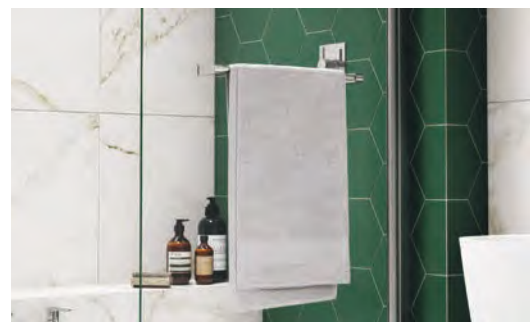

Optional towel rail

Chrome right hand single panel bathscreen



Matt black right hand single panel bathscreen



Brushed brass right hand single panel bathscreen



inspire

Two panel out-swing screens

The Two Panel Out Swing Screens are designed to provide an extended showering area of 950mm, yet still provide easy access to the bath.

Featuring a 305mm fixed panel that is permanently sealed to the bath and providing absolute showering protection. The larger 645mm panel opens out to allow access to shower controls and cleaning.

With Click-to-Lock hinges holding the screen in position, Out-Swing Bath Screens are also available with an integrated rail so you can keep your towel conveniently within reach.

Features & Benefits:

- + 6mm or 8mm glass options
- + Optional towel rail
- + Click-to-Lock hinges
- + SmartSeal technology
- + Lifetime Guarantee
- + Toughened safety glass with Lifeshield™ protection
- + Adjustment for out of true walls
- + Made In Britain

Codes & Demsions

Bath Screens	Chrome Product Code	Matt Black Product Code
Two Panel Out-Swing 6mm - LH	4BASC2PFOUHLHS	4BASC2PFOUHLHSMBK
Two Panel Out-Swing 6mm - RH	4BASC2PFOURHS	4BASC2PFOURHSMBK
Two Panel Out-Swing 6mm - including towel rail - LH	4BASC2PO6L	4BASC2PO6LMBK
Two Panel Out-Swing 6mm - including towel rail - RH	4BASC2PO6R	4BASC2PO6RMBK
Two Panel Out-Swing 8mm - LH	4BASC2PO8NHL	-
Two Panel Out-Swing 8mm - RH	4BASC2PO8NHR	-
Two Panel Out-Swing 8mm - including towel rail - LH	4BASC2PO8L	-
Two Panel Out-Swing 8mm - including towel rail - RH	4BASC2PO8R	-

Note: Kudos Bath screens are designed to fit on most standard straight edge baths.

For best performance and water retention all fixed and moving panels should be parallel to the inner edge of the bath.

Overhead Diagram

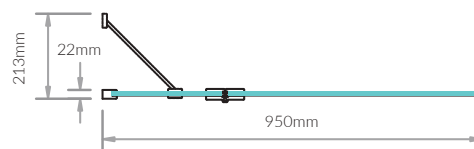
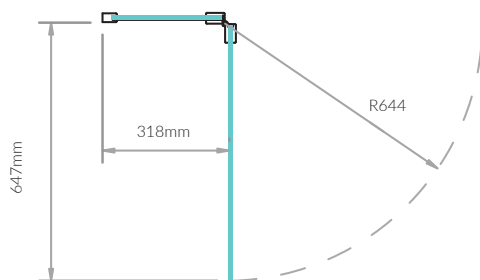

Dimensions: H: 1500mm x W: 950mm

All **inspire** multi panel bath screens are handed, please specify left or right hand fixing when ordering.



Matt black right hand two panel out-swing screen



Chrome right hand two panel out-swing screen



inspire

Two panel in-fold screens

Kudos Two Panel In-Fold Screens feature a 500mm fixed panel that is permanently fixed to the bath and a smaller 375mm in-folding panel which sits behind the fixed panel when not in use, allowing easy access to the bath.

When in use the two panels provide a generous 875mm showering area. High quality Click-to-Lock hinges secure the screen so it is positioned along the inner edge of the bath.

Features & Benefits:

- + 6mm or 8mm glass options
- + Optional towel rail
- + Click-to-Lock hinges
- + SmartSeal technology
- + Lifetime Guarantee
- + Toughened safety glass with Lifeshield™ protection
- + Adjustment for out of true walls
- + Made In Britain

Codes & Demsions

Bath Screens	Chrome Product Code	Matt Black Product Code
Two Panel In-Fold 6mm - LH	4BASCDUOLHS	4BASCDUOLHSMBK
Two Panel In-Fold 6mm - RH	4BASCDUORHS	4BASCDUORHSMBK
Two Panel In-Fold 8mm - LH	4BASCDUO8LH	-
Two Panel In-Fold 8mm - RH	4BASCDUO8RH	-

Note: Kudos Bath screens are designed to fit on most standard straight edge baths. For best performance and water retention all fixed and moving panels should be parallel to the inner edge of the bath.

All **inspire** multi-panel bath screens are handed, please specify left or right hand fixing when ordering.

Overhead Diagram

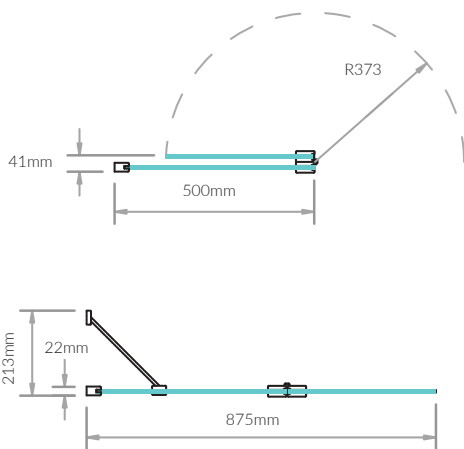

Dimensions: H: 1500mm x W: 875mm

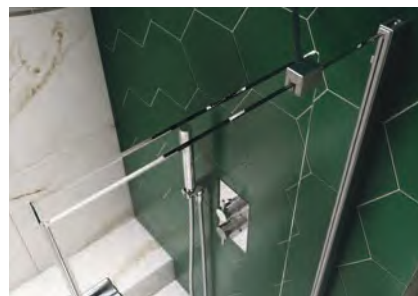

Two panel in closed position



Matt black right hand two panel in-fold bathscreen



Chrome right hand two panel in-fold bathscreen



inspire

Three panel in-fold screens

The stunning Kudos Three Panel In-Fold Screen is the ultimate in over-bath showering protection.

The screen extends to 1250mm, yet folds to just 500mm when not in use providing the features of a relaxing bath as well as the benefit of an oversized shower area. Featuring unique Click-to-Lock hinges to ensure the panels remain in-line when in use.

Features & Benefits:

- + 6mm glass option only
- + Lifetime Guarantee
- + Adjustment for out of true walls
- + Click-to-Lock hinges
- + SmartSeal technology
- + Toughened safety glass with Lifeshield™ protection
- + Made In Britain

Codes & Dimensions

Panel Options	Chrome Product Code	Matt Black Product Code
Three Panel In-Fold 6mm - LH	BASCTRIPLPLHS	BASCTRIPLPLHSMBK
Three Panel In-Fold 6mm - RH	BASCTRIPLPRHS	BASCTRIPLPRHSMBK

Note: Kudos Bath screens are designed to fit on most standard straight edge baths. For best performance and water retention all fixed and moving panels should be parallel to the inner edge of the bath.

Overhead Diagram

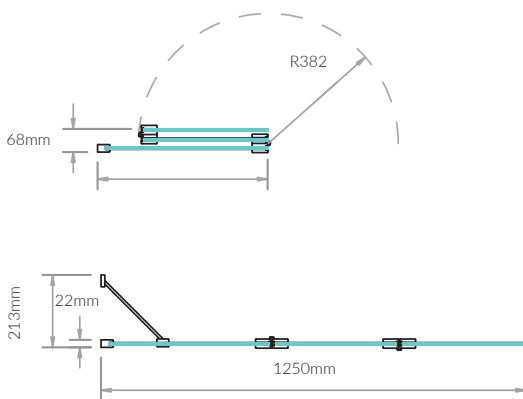

Dimensions: H: 1500mm x W: 1250mm



Three panel in closed position

All **inspire** multi-panel bath screens are handed, please specify left or right hand fixing when ordering.

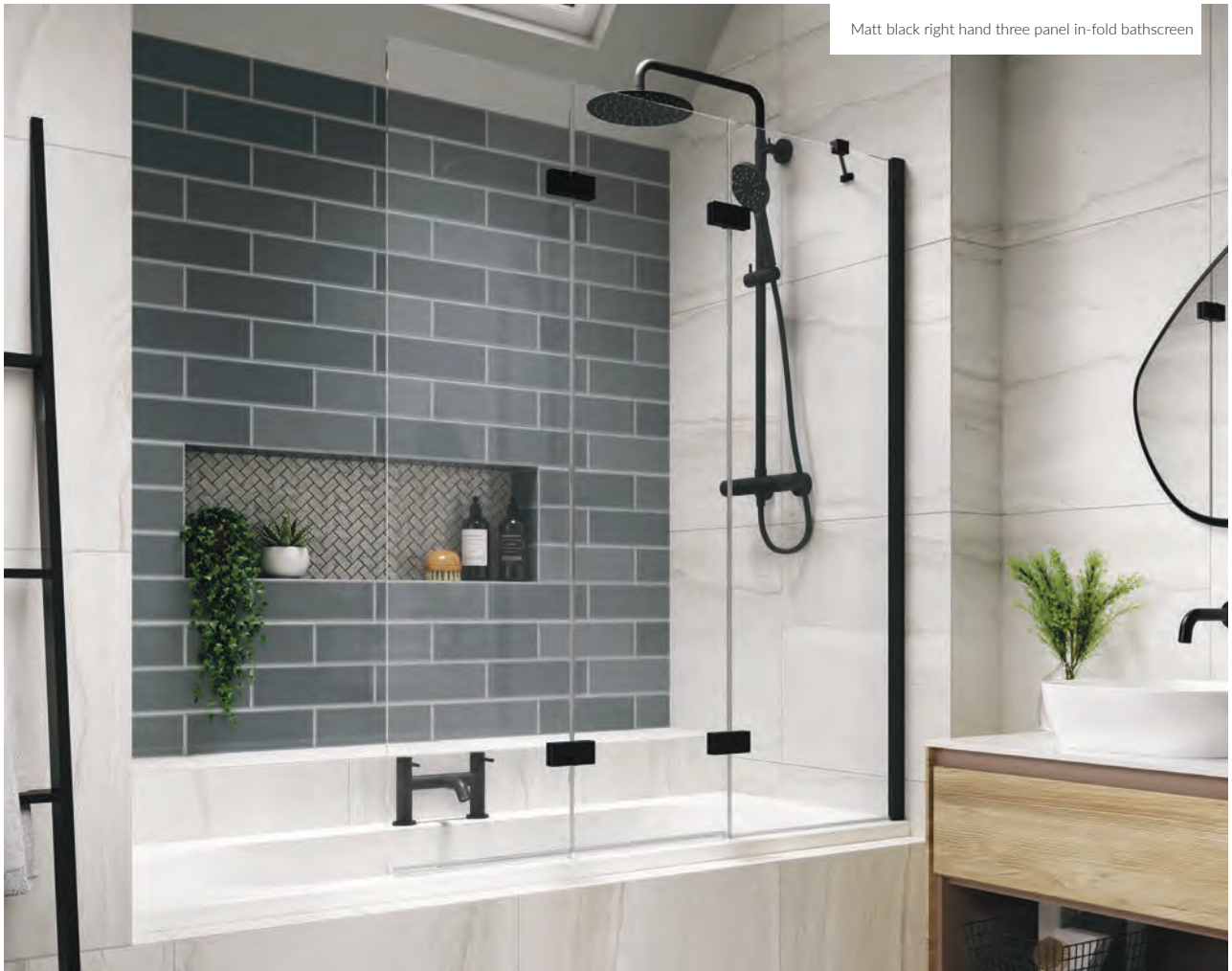

Matt black right hand three panel in-fold bathscreen

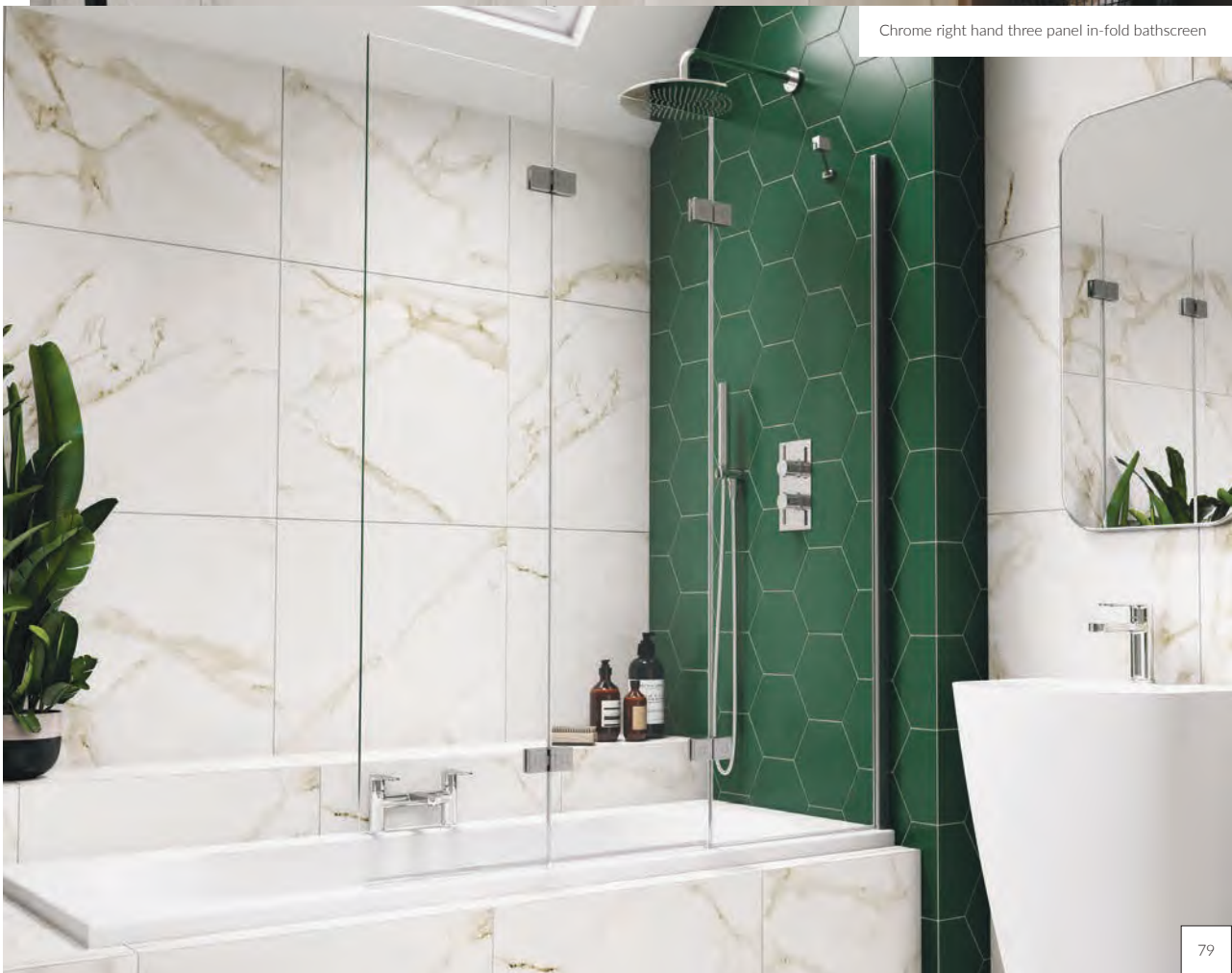

Chrome right hand three panel in-fold bathscreen

inspire

Four panel in-fold screens

For greater access to the bath without compromising on shower protection, the Kudos Four Panel In-Fold Screen is the solution.

Each of the three 215mm hinged panels sit comfortably behind the 305mm fixed panel providing virtually unimpeded access to the bath, yet when in use extends to 950mm for excellent showering protection.

Features & Benefits:

- + 6mm glass option only
- + Lifetime Guarantee
- + Adjustment for out of true walls
- + Click-to-Lock hinges
- + SmartSeal technology
- + Toughened safety glass with Lifeshield™ protection
- + Made In Britain

Codes & Dimensions

Bath Screens	Chrome Product Code	Matt Black Product Code
Four Panel In-Fold 6mm - LH	4BASCOMPLHS	4BASCOMPLHSMBK
Four Panel In-Fold 6mm - RH	4BASCOMPRHS	4BASCOMPRHSMBK

Note: Kudos Bath screens are designed to fit on most standard straight edge baths. For best performance and water retention all fixed and moving panels should be parallel to the inner edge of the bath.

Overhead Diagram

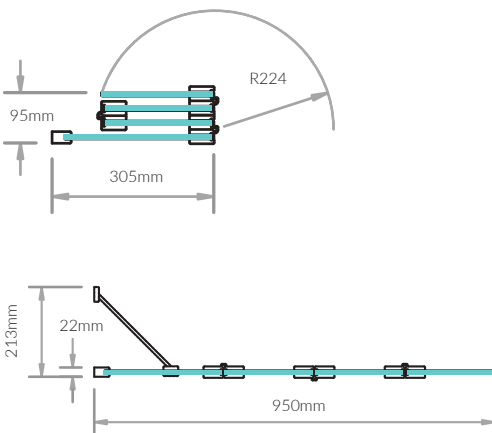

Dimensions: H:1500mm x W:950mm



Four panel in closed position

All **inspire** multi-panel bath screens are handed, please specify left or right hand fixing when ordering.

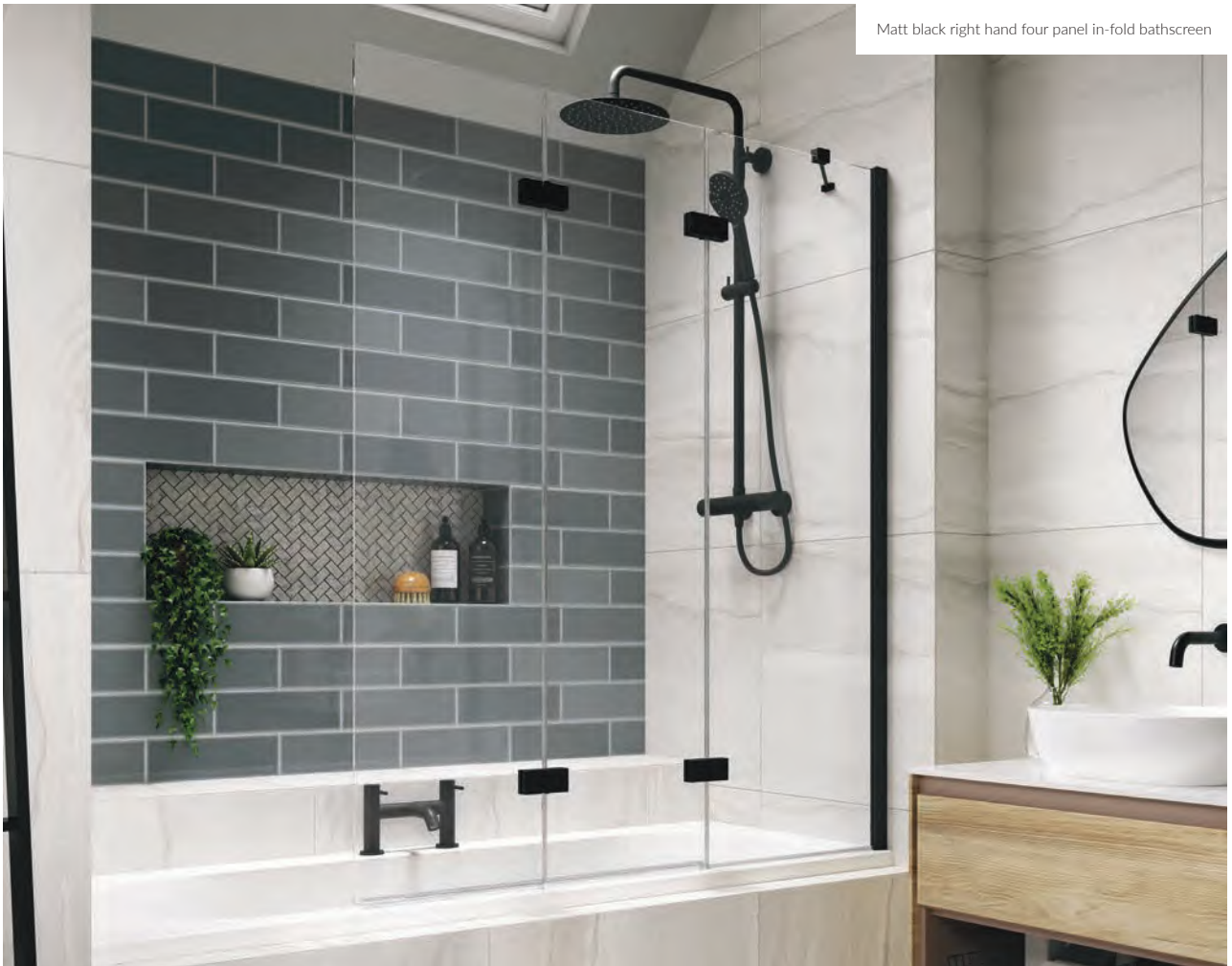

Matt black right hand four panel in-fold bathscreen



Chrome right hand four panel in-fold bathscreen



connect²

Shower trays

The stunning looking connect2 is a uniquely designed shower tray featuring two offset waste positions that ensures an obstruction free connection. Whether square, rectangular or quadrant - whatever the size, the connect2 tray will allow you to connect the waste fitting without the need to reposition joists or raise the tray onto a plinth.

Features & Benefits:

- + Available in three finishes:
 - High Gloss
 - SR finish (slip and stain resistant)
 - Slate effect
- + Unique design avoids the need to cut joists or lift the tray onto a plinth
- + Guaranteed to work with all standard joist sizes and spans
- + Structural resin bonded stone filler for increased stability
- + Super slim at only 35mm high
- + Supplied with a reinforced colour matched waste cover that is magnetically secured, comfortable underfoot and is easily removed for cleaning
- + Covered by the Kudos Lifetime Guarantee



Connect2 high gloss shower tray

A revolution in shower tray design.

High Gloss Shower Tray



The high gloss acrylic capped ABS skin is durable as well as being resistant to impact damage and staining.

Slate Effect Shower Tray



connect2 slate effect trays feature an exclusive surface pattern taken directly from a piece of local slate for a truly authentic finish whilst maintaining the features and benefits of the acrylic surface material. It is both slip and stain resistant and also contains an anti-microbial additive to inhibit the growth of microbes including bacteria and mould.

SR Finish Shower Tray

Slip & Stain Resistant



connect2 SR trays feature the latest development in surface material which exceeds all EU standards for barefoot bathing. The slip resistant properties are embedded in the material, rather than a coating on the surface, meaning it cannot be removed and is comfortable to stand on. The textured surface provides a high level of stain resistance ensuring that your tray maintains a pristine appearance throughout its lifetime



The unique design of the connect2 tray ensures obstruction free waste connection irrespective of joist position or direction.



connect2 trays are supplied with a high flow waste and a blanking plug secured with solvent weld (not supplied) to block the unused waste hole.



connect2 trays are supplied with a stylish colour matched linear waste cover, magnetically secured and reinforced for comfort and stability underfoot.

**Based on industry standard of 400/450/600mm increments as outlined in the NHBC standards 2018*

Whether square, rectangular or the quadrant - whatever the size, the connect2 tray will allow you to connect the waste fitting without the need to reposition joists or raise the tray onto a plinth.

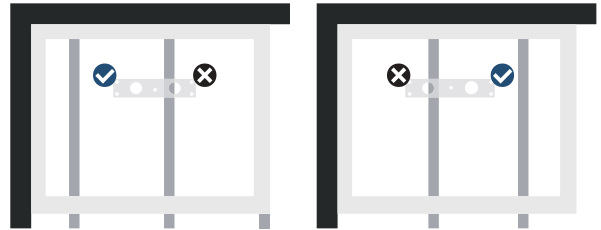

Where joists run parallel to the width of the tray, at least one hole will always be clear.

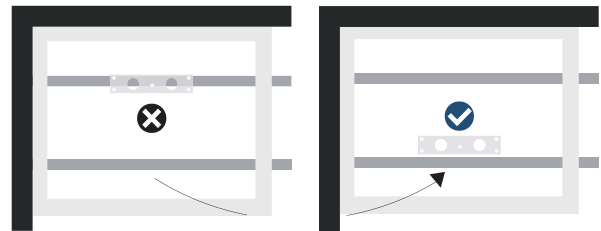

Where joists run parallel to the length of the tray and both holes are obstructed, simply turn the tray 180°. The unique offset position will ensure both will become free.

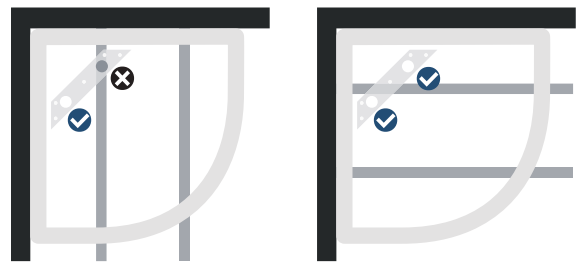

With the unique connect2 design even Quadrant and the Kudos unique Full Curve shape trays have the ability to avoid joists.

Waste locations codes and dimensions.

Waste Locations

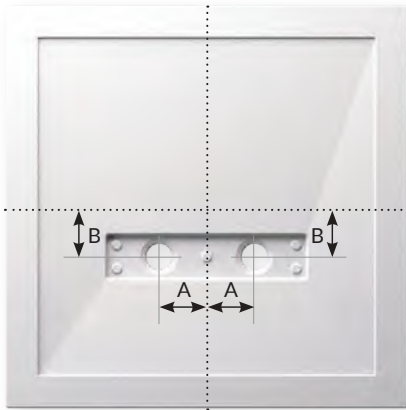

Square & Rectangular shower trays

Position of waste holes relative to the centre of each tray. **All sizes: A - 95mm B - 100mm**

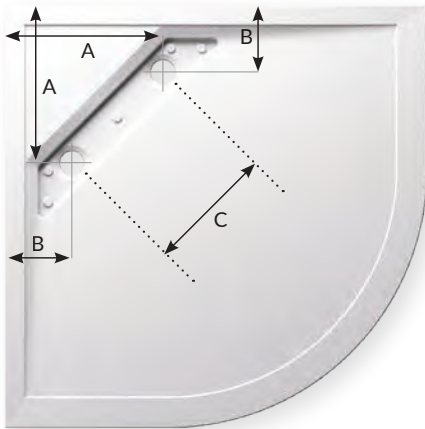

Quadrant & Full Curve shower trays

Position of waste holes in relation to the 90° angle corner.

All sizes: A - 336mm B - 142mm C - 275mm

Codes & Dimensions

Size (Length x Width)		Standard High Gloss Product Code	SR (Slip Resistant) Product Code	Slate Finish Product Code
800mm x 800mm	SQUARE	C2T80	C2T80SR	C2T80SLGR
900mm x 900mm		C2T90	C2T90SR	C2T90SLGR
900mm x 800mm	RECTANGULAR	C2T9080	C2T9080SR	C2T9080SLGR
1000mm x 800mm		C2T10080	C2T10080SR	C2T10080SLGR
1000mm x 900mm		C2T10090	C2T10090SR	C2T10090SLGR
1100mm x 800mm		C2T11080	C2T11080SR	C2T11080SLGR
1200mm x 800mm		C2T12080	C2T12080SR	C2T12080SLGR
1200mm x 900mm		C2T12090	C2T12090SR	C2T12090SLGR
1300mm x 800mm		C2T13080	C2T13080SR	C2T13080SLGR
1400mm x 700mm		C2T14070	C2T14070SR	C2T14070SLGR
1400mm x 800mm		C2T14080	C2T14080SR	C2T14080SLGR
1400mm x 900mm		C2T14090	C2T14090SR	C2T14090SLGR
1500mm x 700mm		C2T15070	C2T15070SR	C2T15070SLGR
1500mm x 800mm		C2T15080	C2T15080SR	C2T15080SLGR
1500mm x 900mm		C2T15090	C2T15090SR	C2T15090SLGR
1600mm x 700mm	C2T16070	C2T16070SR	C2T16070SLGR	
1600mm x 800mm	C2T16080	C2T16080SR	C2T16080SLGR	
1600mm x 900mm	C2T16090	C2T16090SR	C2T16090SLGR	
1700mm x 700mm	C2T17070	C2T17070SR	C2T17070SLGR	
1700mm x 800mm	C2T17080	C2T17080SR	C2T17080SLGR	
1700mm x 900mm	C2T17090	C2T17090SR	C2T17090SLGR	
900mm x 900mm Quadrant	QUADRANT	C2T90Q	C2T90QSR	C2T90QSLGR
1000mm x 1000mm Quadrant	QUADRANT	C2TQ100	C2TQ100SR	C2TQ100SLGR
Offset Quadrant 900mm x 800mm†	OFFSET QUADRANT	C2TQ9080	C2TQ9080SR	C2TQ9080SLGR
Offset Quadrant 1000mm x 800mm†		C2TQ10080	C2TQ10080SR	C2TQ10080SLGR
Offset Quadrant 1000mm x 900mm†		C2TQ1090	C2TQ1090SR	C2TQ1090SLGR
Offset Quadrant 1200mm x 800mm†		C2TQ1280	C2TQ1280SR	C2TQ1280SLGR
Offset Quadrant 1200mm x 900mm†		C2TQ12090	C2TQ12090SR	C2TQ12090SLGR
Product Specific Trays ††				
Curved 910mm	CURVED	C2T91C	C2T91CSR	C2T91CSLGR
Offset Curved 1000mm x 810mm†	CURVED	C2T10081C	C2T10081CSR	C2T10081CSLGR



† Please add **RH** or **LH** to the product code to indicate left or right handing.

†† Connect2 curved trays are product specific and are only suitable for use with Kudos Original6 enclosures.

How to raise your connect2 shower tray

Creating a Fascia Panel

Straight Edge (Square & Rectangular) Trays

A Fascia panel can be created using a moisture resistant material (not supplied) which can then be painted, tiled or alternatively covered with a Kudos Acrylic Decorative Fascia Cover to match the tray material.

Quadrant, Curved & Bow Fronted Trays

Fascia panels for Full Curve or Bow Fronted trays require a flexible moisture resistant material such as marine plywood, which can either be painted, tiled with mosaics or covered with a Kudos Decorative Acrylic Fascia Cover to match the finish of the tray.

Creating a Fascia Panel for Kudos Quadrant Trays

The shape of Quadrant trays require the Fascia board material to be manufactured with machined cuts to enable the plinth to follow the shape of the tray. Kudos Quadrant Fascia Board is pre-machined for this purpose.

This can then be painted, tiled or covered with a Kudos Acrylic Decorative Fascia Cover.

Fascia Covers

*Description	Product Code
Decorative Acrylic Fascia Cover 1200mm High Gloss Finish	C2T12FC
Decorative Acrylic Fascia Cover 1900mm High Gloss Finish	C2T19FC
Decorative Acrylic Fascia Cover 1200mm White SR Finish	C2T12FCSR
Decorative Acrylic Fascia Cover 1900mm White SR Finish	C2T19FCSR
Decorative Acrylic Fascia Cover 1200mm Slate Grey Finish	C2T12FCSLGR
Decorative Acrylic Fascia Cover 1900mm Slate Grey Finish	C2T19FCSLGR
Pre-machined cut flexible Plinth Fascia for Quadrant Trays	C2TQPLF

* All of the above are 150mm high

Essential for Connect2 Trays

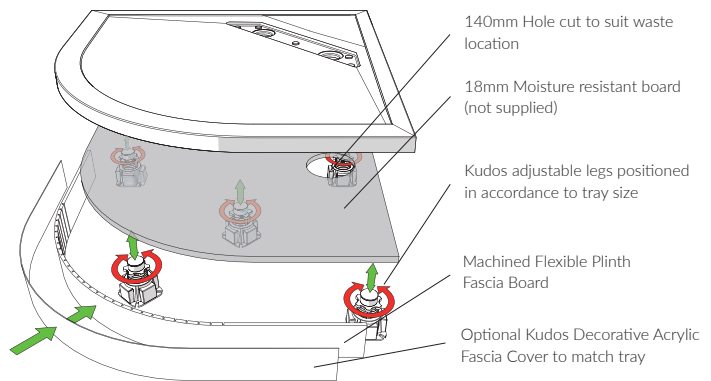
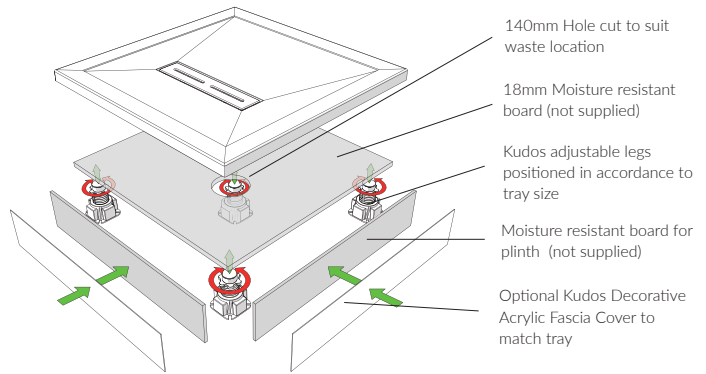

Note: In all cases the Acrylic Decorative Fascia Cover is not to be used without a suitable Fascia board. Sand and cement is still required between the tray and board, please refer to the instructions

Shower Tray Leg Sets

All Kudos Shower Trays are designed to be fitted to either a wooden or concrete floor and should be fully supported. Leg height can be adjusted from min 88mm to max 172mm.

Description & Codes

Description	Product Code
Leg Set Pack of 5 for trays under 1200mm in length	C2T5LSP
Leg set pack of 9 for quadrant and trays 1200mm and over	C2T9LSP

aqua4ma evolution centre waste deck



aqua4ma evolution centre waste deck



aqua4ma

Shower decks and wet-room system

Practical and sophisticated, it's easy to understand why there has been an increase in the number of wet-room installations. Space enhancing and easy to clean, these spa-like bathrooms represent the ultimate in luxury.

Kudos showers have long led the way in simplifying the installation of wet-rooms, with the iconic aqua4ma system having been installed in 1000s of UK homes, the installation process has been further simplified with the introduction of the aqua4ma Evolution wet-room system.

Versatile, reliable and backed by the Kudos lifetime guarantee, aqua4ma evolution and aqua4ma linear decks ensure that you will be able to find the wet-room foundation that is perfect for you.

Features & Benefits

- + Quick and easy to install
- + Easily trimmed to fit or to avoid joist obstruction
- + Suitable for tiles, vinyl* and micro-cement
- + Fit anywhere in the home on wooden or solid floors (see installation guide for full details)
- + Ready for tiling immediately with no wet trades required
- + Floor and wall panels for a total wet-room installation

*Please order vinyl specific waste

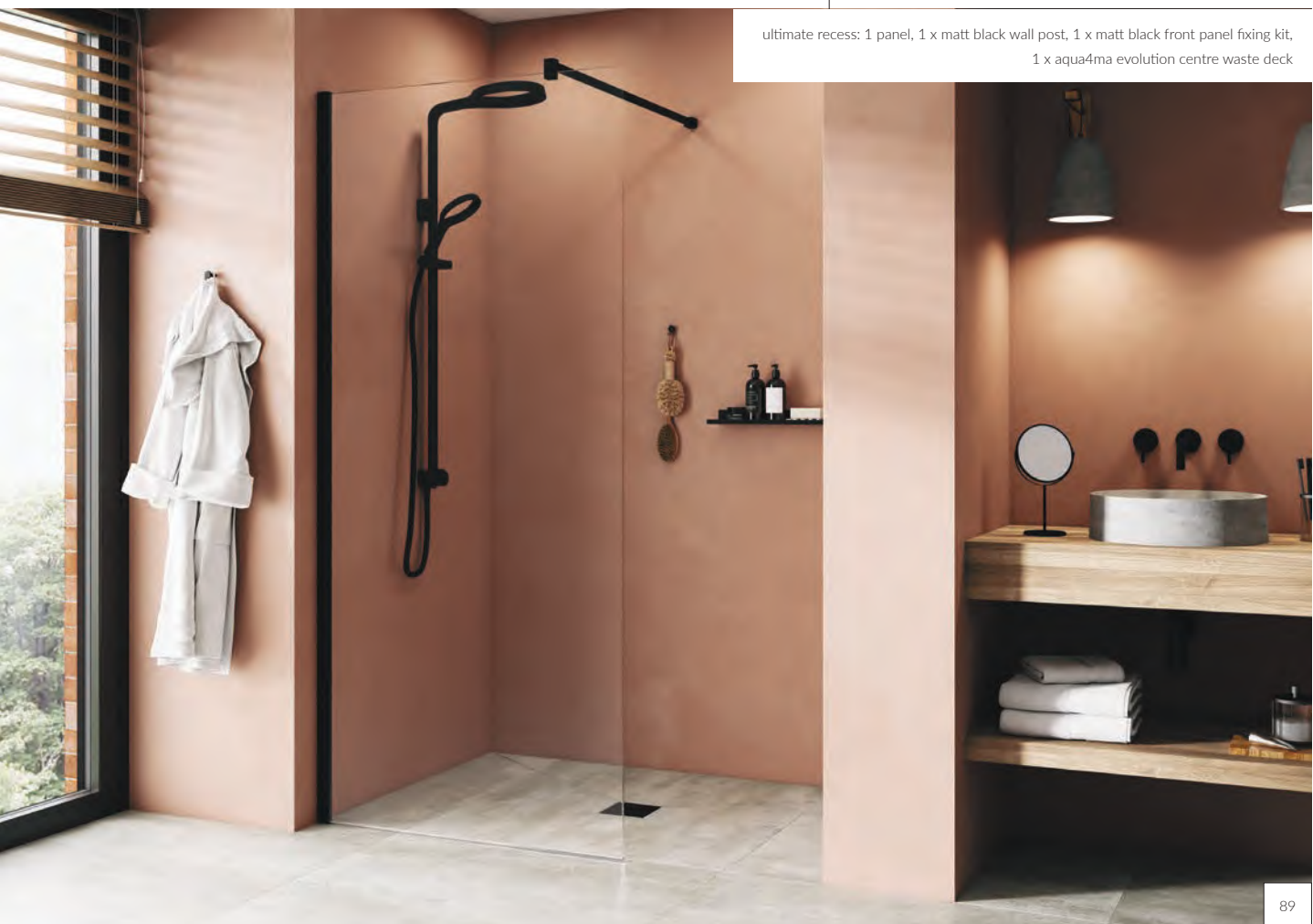

ultimate recess: 1 panel, 1 x matt black wall post, 1 x matt black front panel fixing kit,
1 x aqua4ma evolution centre waste deck

aqua4ma

Evolution shower decks

Versatile and easy to install, aqua4ma evolution has been developed to reflect the demand for lower-level, cost effective, wet-room solutions. Available in two style options, each featuring a 90mm waste, aqua4ma evolution can be installed anywhere in the house on wooden or solid floors and is guaranteed to be waterproof for life.

The perfect partner to the ultimate range of enclosures, aqua4ma evolution can be used in just the showering area or on all walls and floors to create a fully watertight wet-room and is ready to tile/ finish on the same day as installation – saving you both time and money.

Features & Benefits:

- + Quick and easy to install
- + Easily trimmed to fit or to avoid joist obstruction
- + Overall depth of just 25mm
- + Suitable for tiles, vinyl** and micro-cement
- + Fit anywhere in the home on wooden or solid floors
- + Can be fitted at joist level on wooden floors*
- + Ready for tiling/finishing immediately
- + Use with aqua4ma floor and wall panels for a total wet-room solution
- + Lifetime Guarantee
- + British Made

* Decks should be fully supported by creating a false floor between joists



aqua4ma Evolution End Waste Shower Deck:

Measuring 1340 x 1000mm the aqua4ma Evolution End Waste Shower Deck can be easily trimmed from either (or both) sides or from either end that meets a wall.

End waste shower deck consists of:

- + 1340 x 1000mm Evolution Deck
- + Stainless steel waste support plate
- + 2 Side Levelling strips

Waste Assembly (order separately)

- + Tile thickness adjustment mouldings
- + Stainless steel waste grid (Polished Silver or Matt Black)
- + 90mm waste



aqua4ma Evolution Centre Waste Shower Deck:

Available in 7 sizes the aqua4ma Evolution Centre Waste Shower Deck offers a versatile solution for any wet-room installation. Each deck can be trimmed from any side that meets a wall.

Centre waste shower deck consists of:

- + Evolution Deck
- + Stainless steel waste support plate

Waste Assembly (order separately)

- + Tile thickness adjustment mouldings
- + Stainless steel waste grid (Polished Silver or Matt Black)
- + ultimate waste colour options
- + 90mm waste

**Please order vinyl specific waste

aqua4ma evolution end waste deck



aqua4ma evolution centre waste deck



aqua4ma

Linear shower decks

Versatile and easy to install, aqua4ma linear is an ultra low-level (just 19mm deep), cost effective, wet-room solution. Featuring a stylish tileable waste cover and a 90mm waste, aqua4ma linear can be installed anywhere in the house on wooden or solid floors and is guaranteed to be waterproof for life.

The perfect partner to the ultimate range of enclosures, aqua4ma linear can be used in just the showering area or on all walls and floors to create a fully watertight wet-room and is ready to finish on the same day as installation - saving you both time and money.

Features & Benefits:

- + Quick and easy to install
- + Easily trimmed to fit or avoid joist obstruction
- + Overall depth of 19mm
- + For use with tiles
- + Fit anywhere in the home on wooden or solid floors
- + Ready for tiling/finishing straight away with no wet trades required
- + Use with aqua4ma floor and wall panels for a total wet-room solution
- + Lifetime guarantee

Linear shower deck consists of:

- + 1330 x 1000mm shower deck
- + Stainless steel tray
- + 2 sided levelling strips
- + 1 tube of adhesive

Waste Assembly (order separately):

- + 90mm waste for linear





aqua4ma

Panels

Wall & Floor Panels

The aqua4ma range of wall and floor panels allow you to create a water tight space that meets your requirements. aqua4ma panels provide the versatility and peace of mind you're looking for.

aqua4ma panels are available in 4 thicknesses: 7mm, 15mm, 19mm (for use with aqua4ma linear only) and 25mm. With either two or three

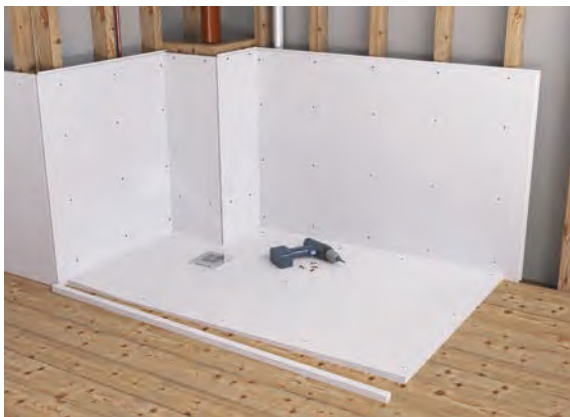

aqua4ma 7mm panels

Perfect for creating a fully waterproof floor, aqua4ma 7mm panels can be used (on top of plywood as necessary) to create level access by raising the floor to the same level as the deck ready for tiling. The 7mm panels can also be affixed to solid walls to create watertight walls.

aqua4ma 15mm panels

The 15mm tongue and grooved panels can be screwed directly to battens in place of plasterboard and, as the material self seals around screws, no washers or additional sealing is necessary. The above illustration shows how the 15mm panels can be used to box in pipe work as necessary too.

aqua4ma 19mm panels

For use with the aqua4ma linear decks, the 19mm panels can be used to create level access when using Aqua4ma linear. The panels are the same depth as the deck allowing you to extend the waterproof are quickly and easily, simply bond the joints with aqua4ma solvent weld for a fully watertight floor.

panels in a pack (with the exception of 25mm which are available in either singles or a two pack), the panels measure 1200 x 800mm providing a square metre of coverage. As with aqua4ma shower decks the shower panels are easily trimmable and can be fitted to either floor or walls using either screws or flexible tile adhesive as appropriate.



aqua4ma 25mm panels

For use with the aqua4ma evolution decks, the 25mm panels can be used to create level access when using aqua4ma evolution. The panels are the same depth as the deck allowing you to extend the waterproof are quickly and easily, simply bond the joints with aqua4ma solvent weld for a fully watertight floor.

You can use these 25mm panels to make a seat, for shelving, for boxing or any structure you wish to create! Simply solvent weld and screw the panels together and to the aqua4ma wall/ floor panels.



Scan the QR code for more information and watch the aqua4ma video

Choosing what you need to create your perfect wet-room

Product Codes

Evolution Shower Decks

Centre Waste Decks	Product Code
1000mm x 900mm	WREV10090CW
1200mm x 900mm	WREV12090CW
1400mm x 900mm	WREV14090CW
1600mm x 900mm	WREV16090CW
1800mm x 900mm	WREV18090CW
2000mm x 900mm	WREV20090CW
1200mm x 1200mm	WREV120120CW

aqua4ma Shower Panels

Panel Sizes	Product Code
1200 x 800 x 7mm Pack of 2 (1.92m ²)	WRAQ72
1200 x 800 x 7mm Pack of 3 (2.88m ²)	WRAQ73
1200 x 800 x 15mm Pack of 2 (1.92m ²)	WRAQ152
1200 x 800 x 15mm Pack of 3 (2.88m ²)	WRAQ153
1200 x 800 x 25mm Pack of 1 (0.96m ²)	WRAQ251
1200 x 800 x 25mm Pack of 2 (1.92m ²)	WRAQ252

Evolution Shower Deck

End Waste Deck	Product Code
1340mm x 1000mm	WREV134100EW

Evolution Wastes

Wastes*	Product Code
Tiled Waste (Polished Stainless Steel)	WRWAE
Tiled Waste (Matt Black)	WRWAEMBK
Vinyl Waste (Polished Stainless Steel)	WRVWE
Vinyl Waste (White)	WRVWAEWH

*aqua4ma Waste is required

aqua4ma Skirting[†]

Skirting	Product Code
1200mm x 75mm (Pack of 4)	WRAQSK134

[†]For a perfect, watertight, installation Aqua4ma skirting or wall panels should be fitted wherever Aqua4ma decks or floor panels meet a wall

Linear Shower Deck

Deck Sizes	Product Code
1330 x 1000 Linear Shower Deck Kit	WRL133100

Linear Waste

Wastes*	Product Code
Waste For Linear	WRWAL

*aqua4ma Waste is required

Linear Shower Panels

Panel Packs	Product Code
1200 x 800 x 19mm Pack of 2	WRAQ192
1200 x 800 x 19mm Pack of 3	WRAQ193

Solvent Weld

aqua4ma Solvent Weld	Product Code
310ml Tube**	WRSW

**Solvent weld paste will join approx. 10 linear metres per tube



bespoke

Showering solutions

Established for 25 years, Kudos Showers is recognised in the industry for the quality, design and workmanship associated with their extensive product range.

From showers to bathscreens, enclosures to wet-room systems, everything is designed in-house by a team of people with keen attention to detail – ensuring that every Kudos product is built to the same exacting standards.

Kudos Showers also recognise that sometimes products from their core ranges don't meet the customer's requirements – that could be because they're working with an unusual sized space, or have a very specific 'look' in mind. On these occasions, the Bespoke by Kudos range and service really comes into its own.

The 'Bespoke by Kudos' team will work with you to create the shower enclosure that best meets your needs.

Our bespoke design team can produce showering solutions that are tailor made to your requirements.





Why choose 'Bespoke By Kudos' for your tailor made solution

Quite simply put, Kudos offer the best in market Bespoke solution, we will work with you from measuring* the space you have available to design specification and quote, right the way through to installation**, all the while ensuring that your specific needs are at the forefront of what we do.

Every Bespoke enclosure is manufactured and hand-finished by our in-house team, ensuring that each enclosure is given the same level of care and attention.

We offer a 'measure only**' or 'measure and install***' service, designed to give you additional peace of mind. One of our Support Team will visit and measure the space that has been allocated for your enclosure and, if you wish, will also install the enclosure for you once it's ready.

Glass Colour Options †

- Satin Frosted
- Bronze Tint
- Smoke Grey

† Despite every effort to provide accurate images of each product's colour and design, actual colours and design may vary slightly.

Available Colour Finishes ††

- Chrome
- Matt Black
- Brushed Brass
- Brushed Nickel
- Polished Gold
- Gun Metal
- Polished Bronze
- White
- Brushed Bronze

†† Colour Finish options may vary according to selected range.

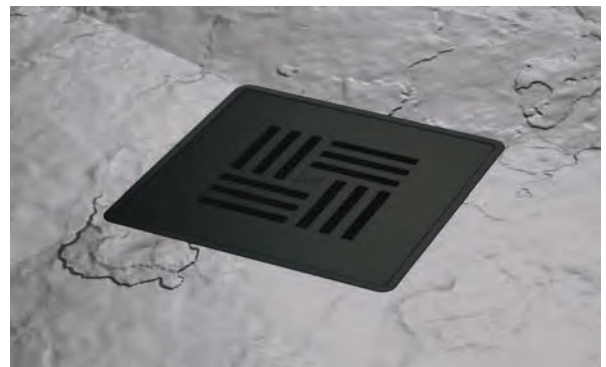
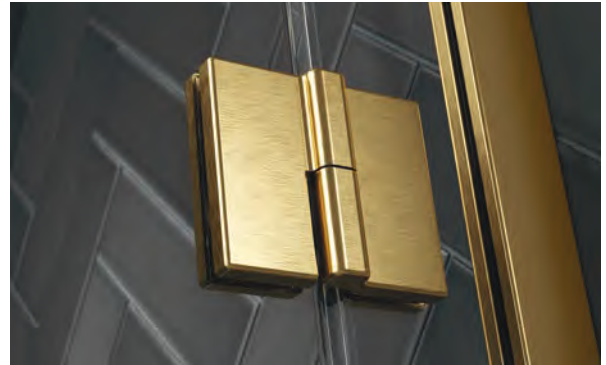

Why choose 'Bespoke By Kudos' for your tailor made solution

How to order...

Ordering from our Bespoke team couldn't be simpler, just 5 steps to your perfect showering solution:

- 1** Contact your Kudos Retailer who will send us a rough drawing of what you're trying to achieve and/ or the space that you have available. We will confirm if we are able to accommodate your request and will provide you with a guide price.
- 2** If you wish to proceed you will need to provide the following an accurate drawing of the space that is available, alternatively this is the point at which you can opt to use our measuring service.
- 3** Once final measurements have been received we will provide a detailed drawing, final price and an estimated delivery date.
- 4** Once you sign the drawings off a deposit will be required before we move to step 5
- 5** Once your product is ready we will arrange for delivery and (if you have opted for the measure and fit service) arrange a date for our Support Team colleague to install your enclosure.

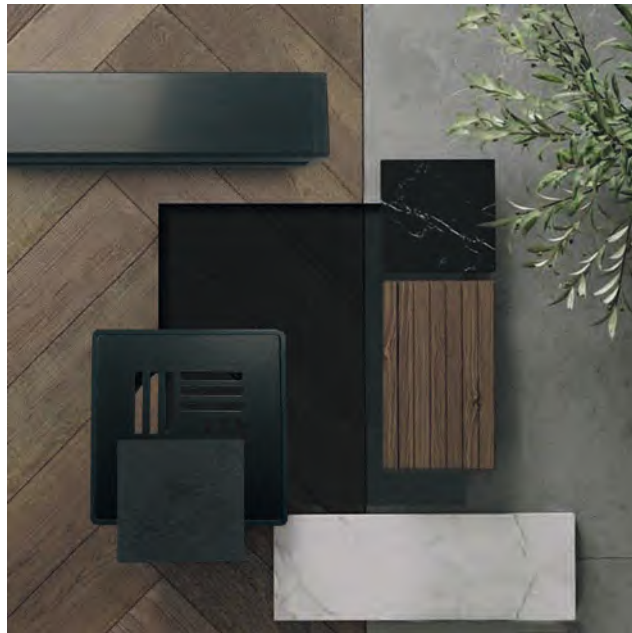

KUDOS

SHOWERING SOLUTIONS

www.kudosshowers.co.uk



RONAL Bathrooms UK Ltd.

Elmsfield Park, Holme

Cumbria LA6 1RJ

United Kingdom

Telephone: +44 (0)1539 564040

Fax: +44 (0)1539 564141

Email: sales@kudosshowers.co.uk

www.kudosshowers.co.uk

Version: 1.0 - 04/2025